

SECTION A-A

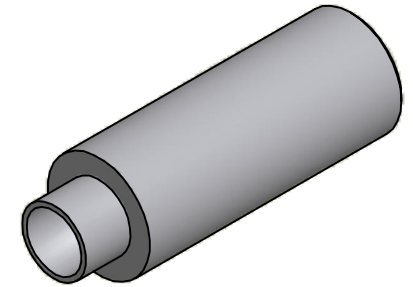

ISO SCALE 2 : 1

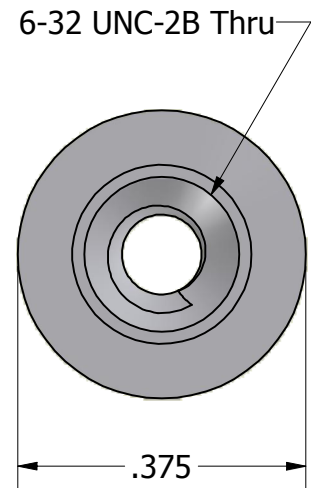
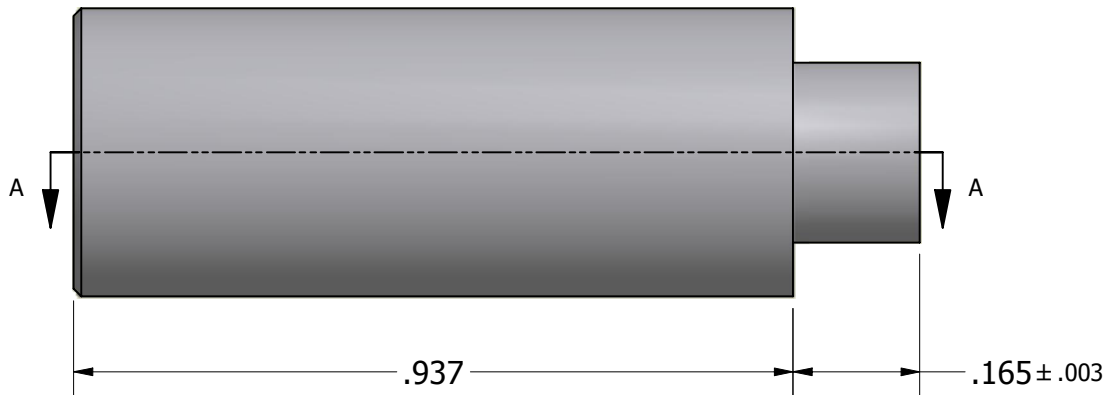

Tolerances Unless Otherwise Specified:

.xx Decimal: ± .02
 .xxx Decimal: ± .005
 Fraction: ± 1/64
 Angle: ± 2°

LYN-TRON, INC.

Part Number:

SS6912D-0.937

Description:

3/8 Round Swage Standoff

Drawn By:

COURTNEYS06/23/2010

Gauge:

Material:

Stainless Steel

Scale:

4 : 1