

SECTION A-A

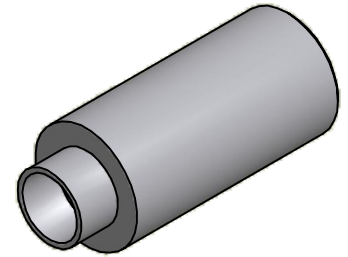

ISO SCALE 2 : 1

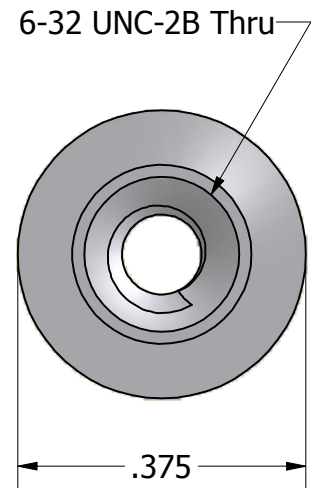
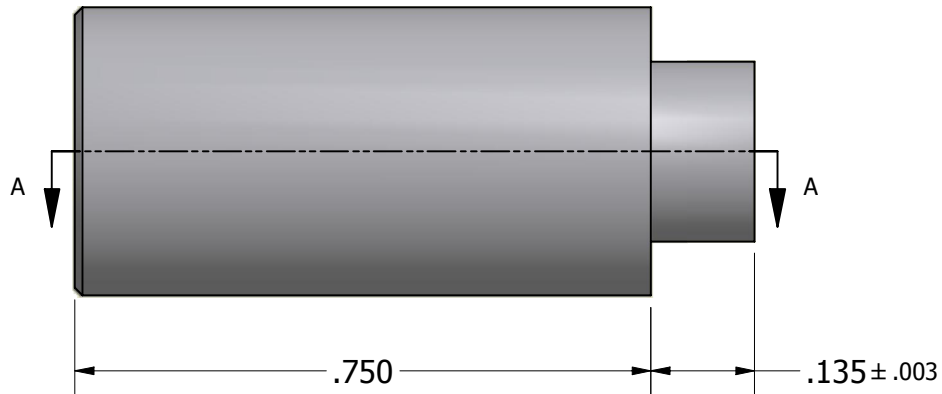

Tolerances Unless Otherwise Specified:

.xx Decimal:  $\pm .02$   
 .xxx Decimal:  $\pm .005$   
 Fraction:  $\pm 1/64$   
 Angle:  $\pm 2^\circ$

**LYN-TRON, INC.**

Part Number:

**SS6912C-0.750**

Description:

**3/8 Round Swage Standoff**

Drawn By:

**COURTNEYS06/23/2010**

Gauge:

Material:

**Stainless Steel**

Scale:

**4 : 1**