

SECTION A-A

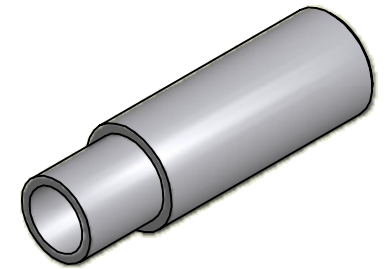

ISO SCALE 4 : 1

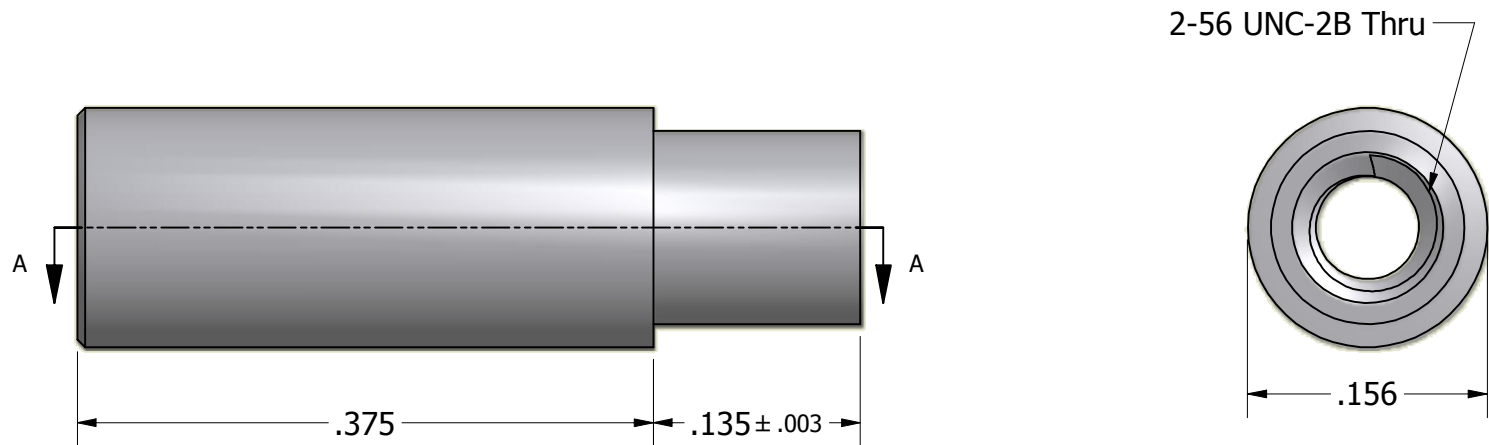

Tolerances Unless Otherwise Specified:

.xx Decimal: ± .02
.xxx Decimal: ± .005
Fraction: ± 1/64
Angle: ± 2°

LYN-TRON, INC.

Part Number:
SS6909C-0.375

Description:
5/32 Round Swage Standoff

Drawn By:
JEFFN 06/18/2010

Gauge:

Material:
Stainless Steel

Scale:
8 : 1