

ISO SCALE 2 : 1

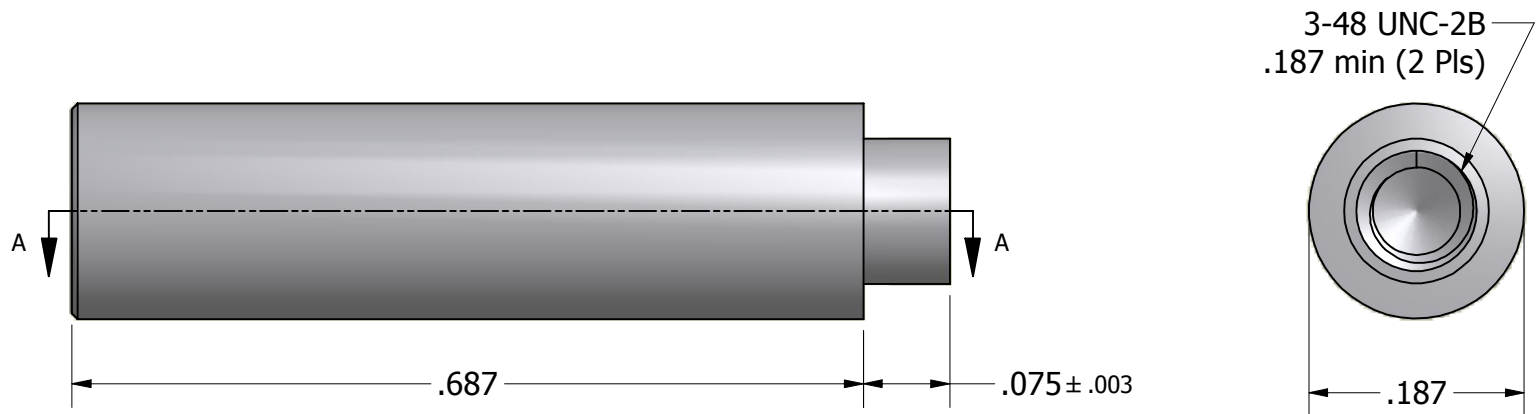

Tolerances Unless Otherwise Specified:

**.xx Decimal:**  $\pm .02$   
**.xxx Decimal:**  $\pm .005$   
**Fraction:**  $\pm 1/64$   
**Angle:**  $\pm 2^\circ$

**LYN-TRON, INC.**

Part Number:

**SS6908A-0.687**

Description:

**3/16 Round Swage Standoff**

Drawn By:

**JEFFN**

**06/17/2010**

Gauge:

Material:

**Stainless Steel**

Scale:

**6 : 1**