

ISO SCALE 3 : 1

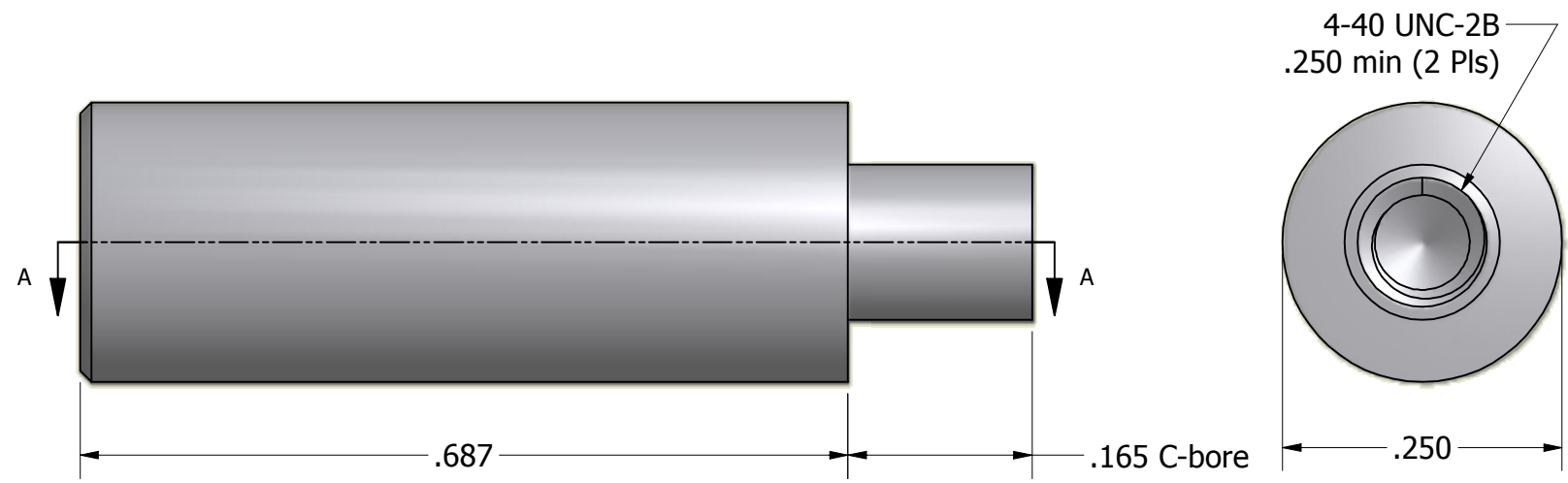

Tolerances Unless Otherwise Specified:

.xx Decimal: $\pm .02$
.xxx Decimal: $\pm .005$
Fraction: $\pm 1/64$
Angle: $\pm 2^\circ$

LYN-TRON, INC.

Part Number:
SS6905D-0.687

Description:
1/4 Round Swage Standoff

Drawn By:
JEFFN 06/23/2010

Gauge:

Material:
Stainless Steel

Scale:
6 : 1