

SECTION A-A

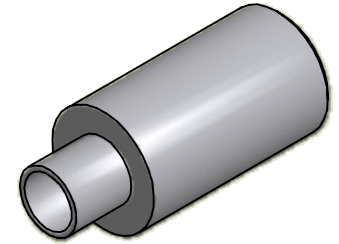

ISO SCALE 3 : 1

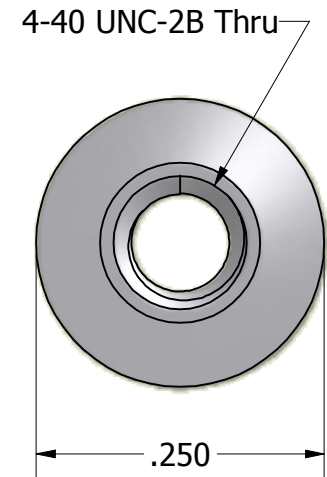
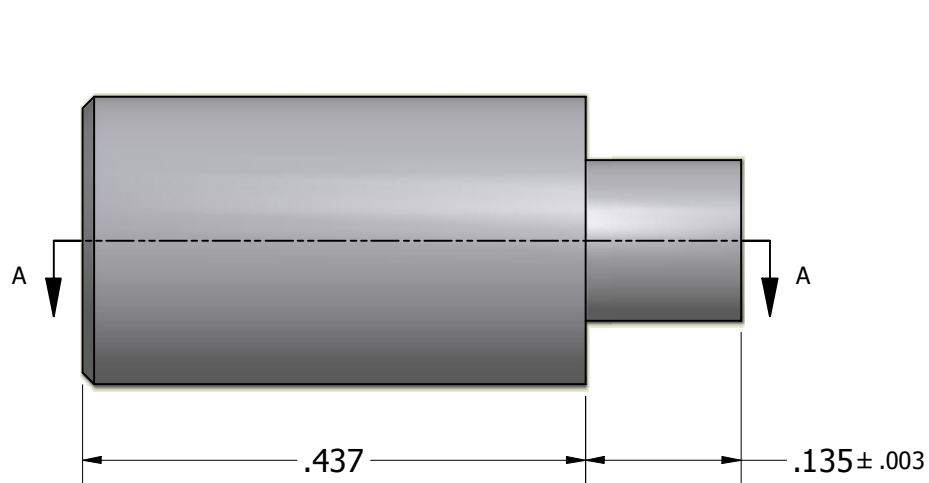

Tolerances Unless Otherwise Specified:

.xx Decimal: ± .02  
 .xxx Decimal: ± .005  
 Fraction: ± 1/64  
 Angle: ± 2°

**LYN-TRON, INC.**

Part Number:

**SS6905C-0.437**

Description:

**1/4 Round Swage Standoff**

Drawn By:

**JEFFN**

**06/23/2010**

Gauge:

Material:

**Stainless Steel**

Scale:

**6 : 1**