

SECTION A-A

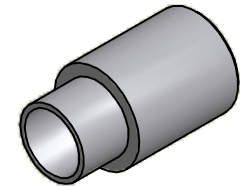

ISO SCALE 2 : 1

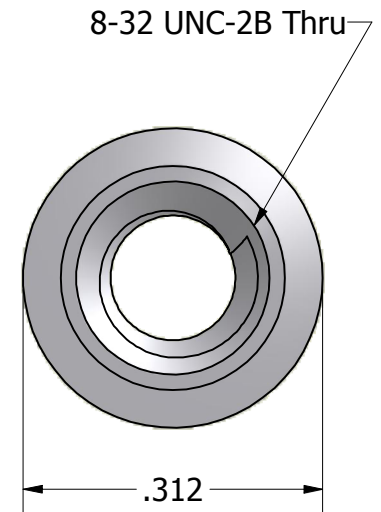
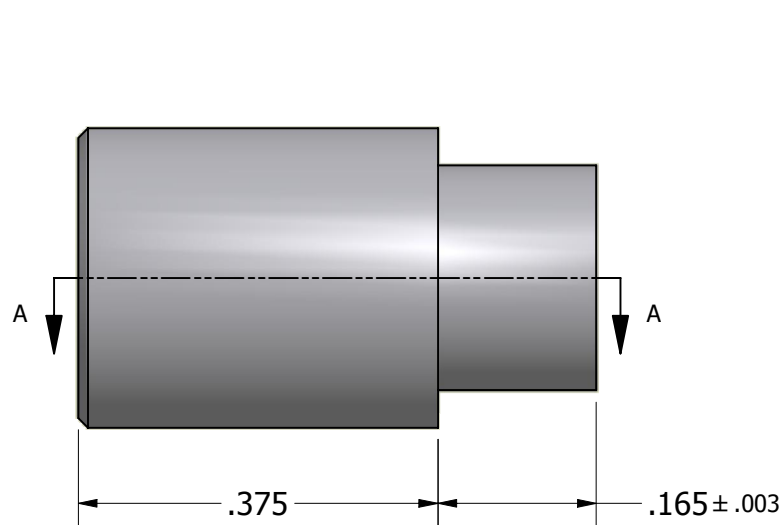

Tolerances Unless Otherwise Specified:

.xx Decimal:  $\pm .02$   
 .xxx Decimal:  $\pm .005$   
 Fraction:  $\pm 1/64$   
 Angle:  $\pm 2^\circ$

**LYN-TRON, INC.**

Part Number:

**SS6903D-0.375**

Description:

**5/16 Round Swage Standoff**

Drawn By:

**JEFFN**

**06/23/2010**

Gauge:

Material:

**Stainless Steel**

Scale:

**5 : 1**