

SECTION A-A

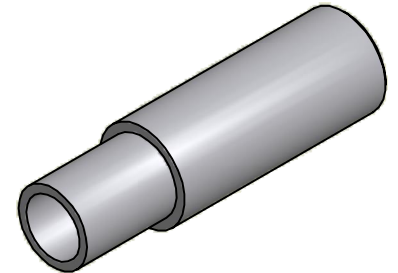

ISO SCALE 4 : 1

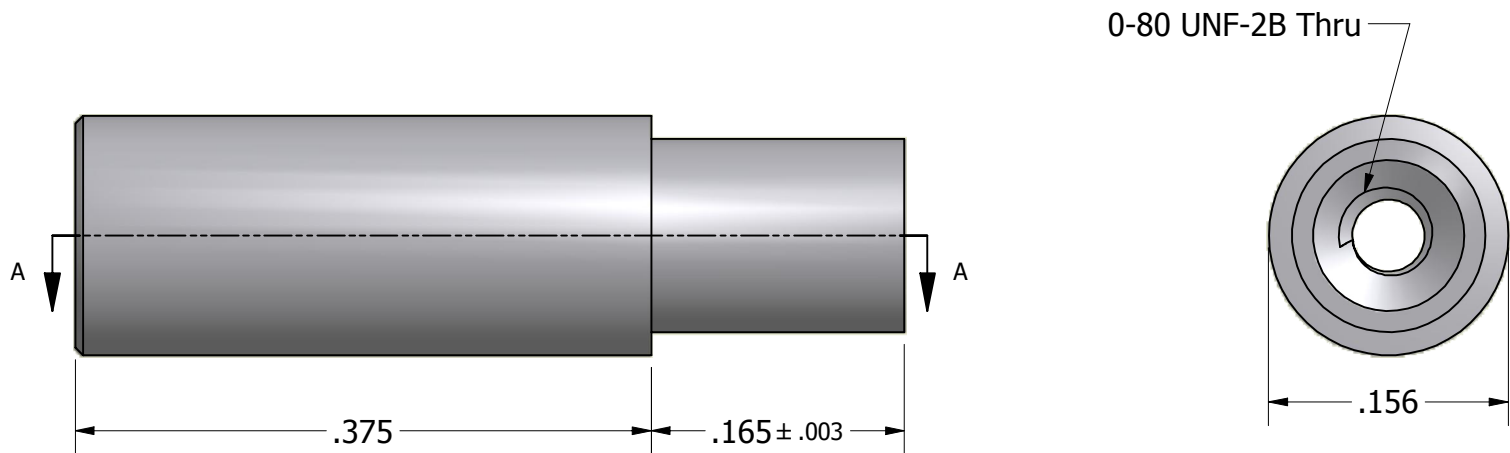

Tolerances Unless Otherwise Specified:

.xx Decimal: ± .02
.xxx Decimal: ± .005
Fraction: ± 1/64
Angle: ± 2°

LYN-TRON, INC.

Part Number:

SS6902D-0.375

Description:

5/32 Round Swage Standoff

Drawn By:

JEFFN

06/18/2010

Gauge:

Material:

Stainless Steel

Scale:

8 : 1