

SECTION A-A

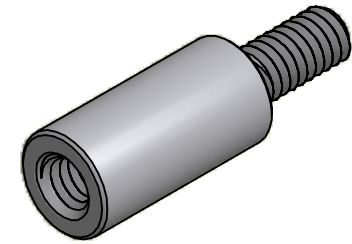

ISO SCALE 2 : 1

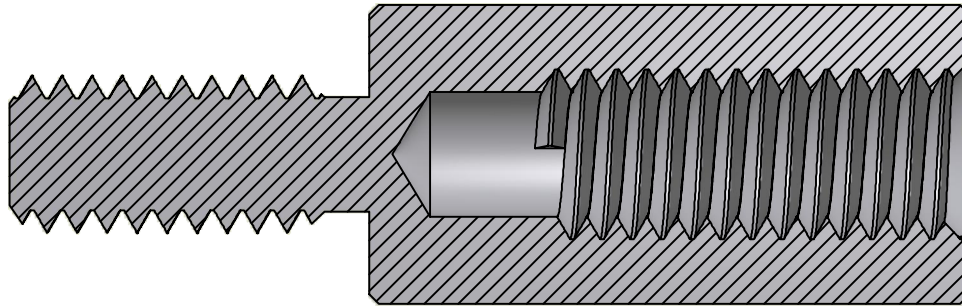
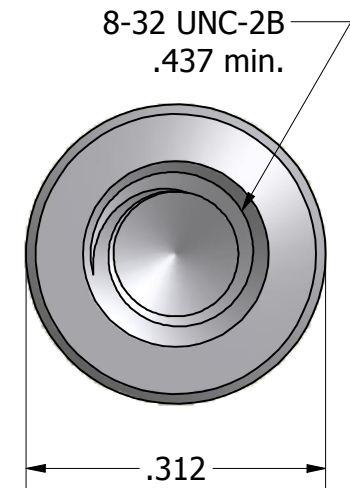
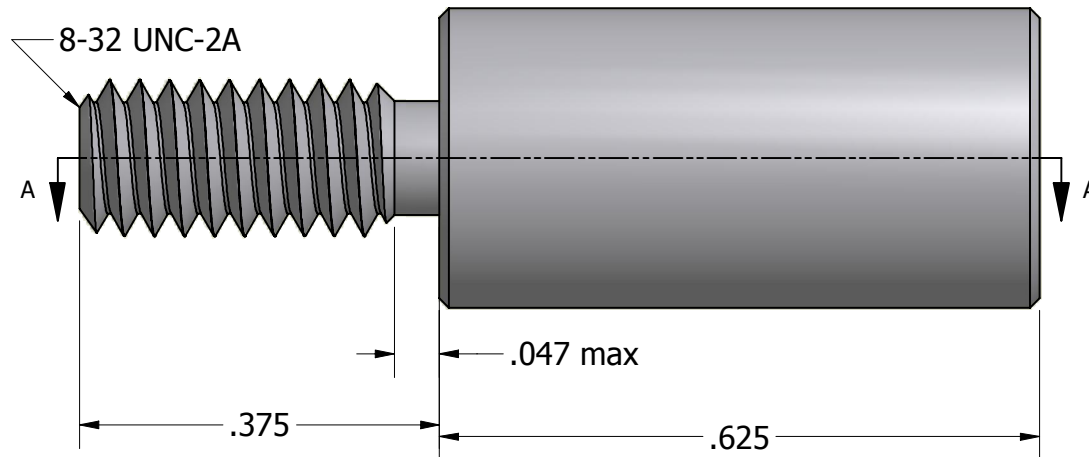

Tolerances Unless Otherwise Specified:

.xx Decimal: ± .02
.xxx Decimal: ± .005
Fraction: ± 1/64
Angle: ± 2°

LYN-TRON, INC.

Part Number:

SS6894-0.625

Description:

5/16 Round Male-Female Standoff

Drawn By:

KENANG 07/08/2011

Gauge:

Material:

Stainless Steel

Scale:

5 : 1