

SECTION A-A

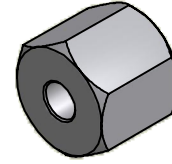

ISO SCALE 1 : 1

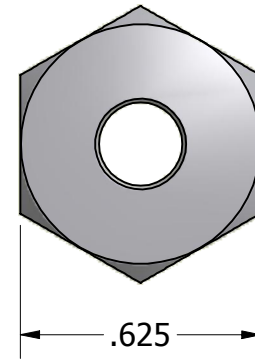
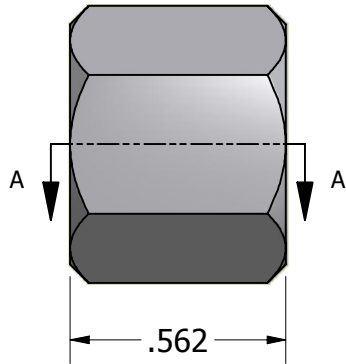

Tolerances Unless Otherwise Specified:

.xx Decimal: ± .02
.xxx Decimal: ± .005
Fraction: ± 1/64
Angle: ± 2°

LYN-TRON, INC.

Part Number:

SS6356-12-0.562

Description:

5/8 Hex Spacer

Drawn By:

JEFFN

06/20/2010

Gauge:

Material:

Stainless Steel

Scale:

2 : 1