

$\varnothing.140^{+.010}_{-.000}$

SECTION A-A

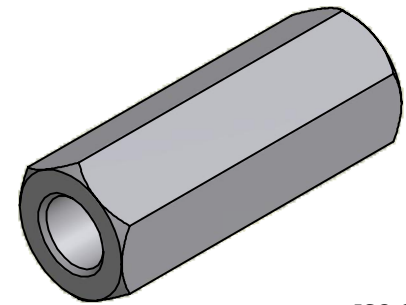

ISO SCALE 3 : 1

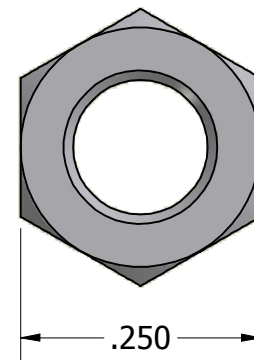
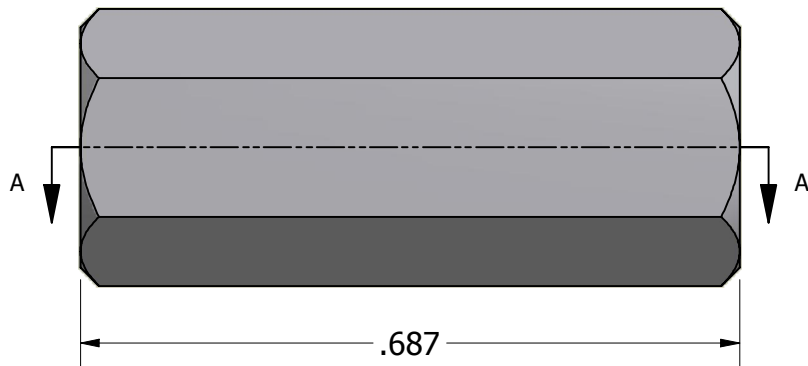

Tolerances Unless Otherwise Specified:

.xx Decimal: $\pm .02$
.xxx Decimal: $\pm .005$
Fraction: $\pm 1/64$
Angle: $\pm 2^\circ$

LYN-TRON, INC.

Part Number:

SS6351-06-0.687

Description:

1/4 Hex Spacer

Drawn By:

COURTNEYS06/20/2010

Gauge:

Material:

Stainless Steel

Scale:

5 : 1