

SECTION A-A

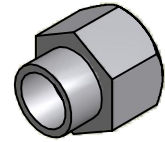

ISO SCALE 3 : 1

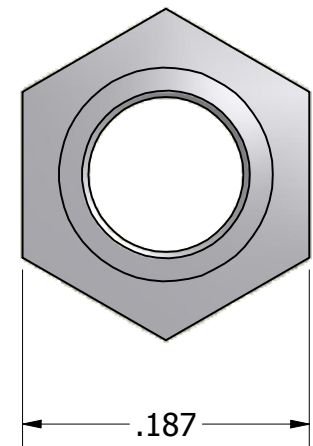
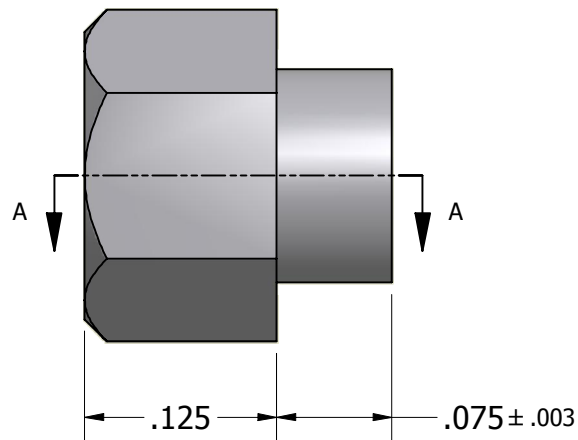

Tolerances Unless Otherwise Specified:

.xx Decimal: $\pm .02$
 .xxx Decimal: $\pm .005$
 Fraction: $\pm 1/64$
 Angle: $\pm 2^\circ$

LYN-TRON, INC.

Part Number:

SS6336A-0.125

Description:

3/16 Hex Swage Spacer

Drawn By:

COURTNEYS05/05/2011

Gauge:

Material:

Stainless Steel

Scale:

8 : 1