

SECTION A-A

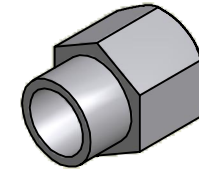

ISO SCALE 4 : 1

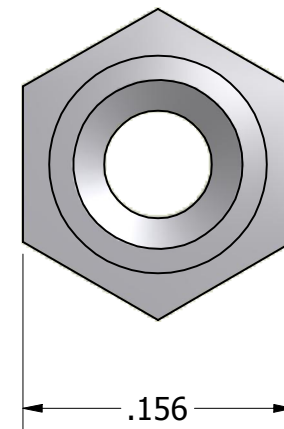
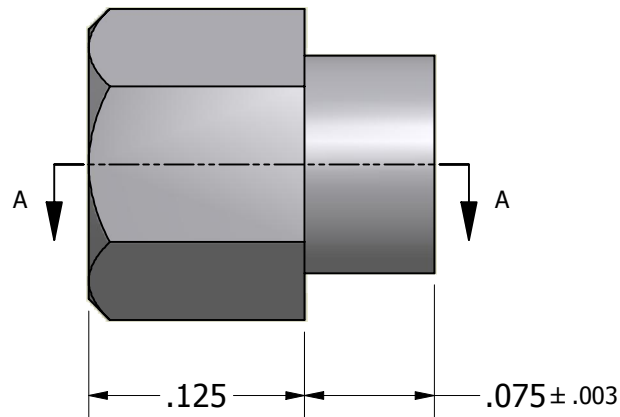

Tolerances Unless Otherwise Specified:

.xx Decimal: $\pm .02$
.xxx Decimal: $\pm .005$
Fraction: $\pm 1/64$
Angle: $\pm 2^\circ$

LYN-TRON, INC.

Part Number:

SS6322A-0.125

Description:

5/32 Hex Swage Spacer

Drawn By:

COURTNEYS05/04/2011

Gauge:

Material:

Stainless Steel

Scale:

9 : 1