

SECTION A-A

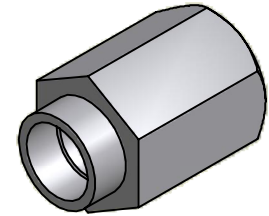

ISO SCALE 3 : 1

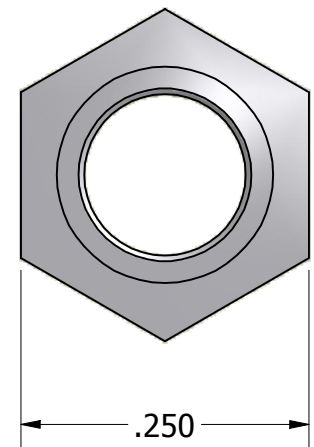
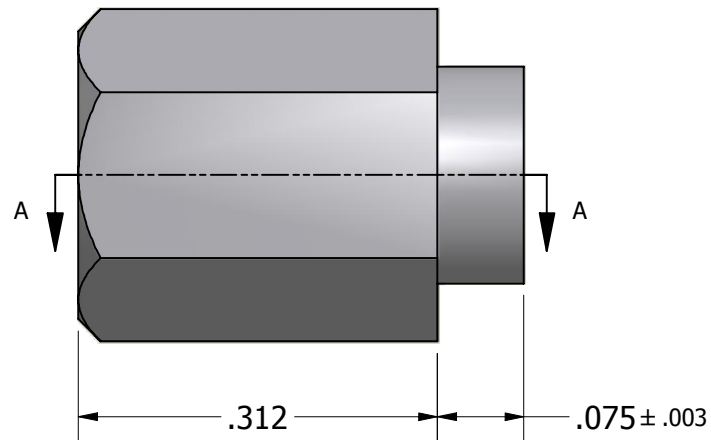

Tolerances Unless Otherwise Specified:

.xx Decimal: $\pm .02$
 .xxx Decimal: $\pm .005$
 Fraction: $\pm 1/64$
 Angle: $\pm 2^\circ$

LYN-TRON, INC.

Part Number:

SS6320A-0.312

Description:

1/4 Hex Swage Spacer

Drawn By:

COURTNEYS05/04/2011

Gauge:

Material:

Stainless Steel

Scale:

6 : 1