

SECTION A-A

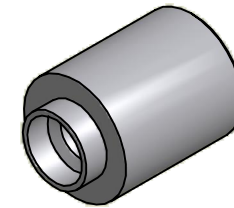

ISO SCALE 2 : 1

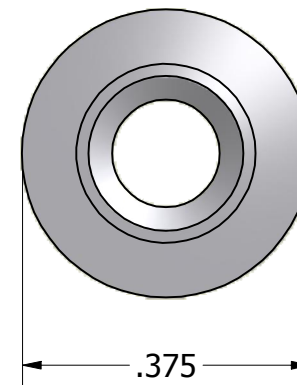
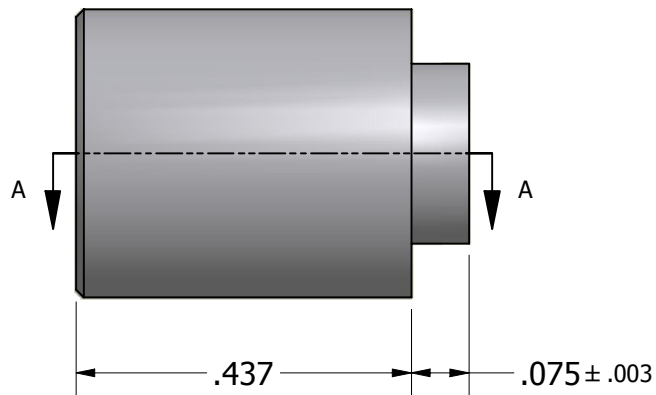

Tolerances Unless Otherwise Specified:

**.xx Decimal:**  $\pm .02$   
**.xxx Decimal:**  $\pm .005$   
**Fraction:**  $\pm 1/64$   
**Angle:**  $\pm 2^\circ$

**LYN-TRON, INC.**

Part Number:

**SS6312A-0.437**

Description:

**3/8 Round Swage Spacer**

Drawn By:

**COURTNEYS04/29/2011**

Gauge:

Material:

**Stainless Steel**

Scale:

**4 : 1**