

SECTION A-A

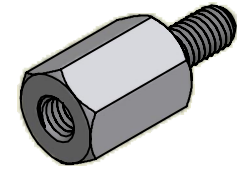

ISO SCALE 1 : 1

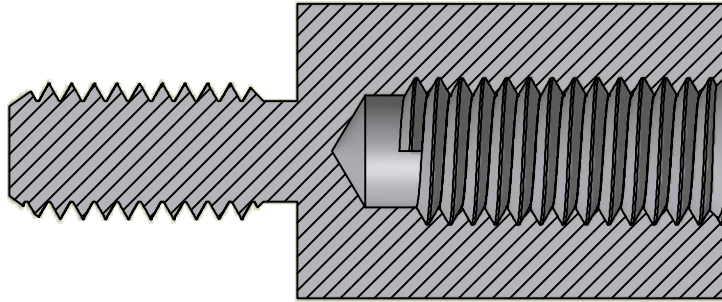
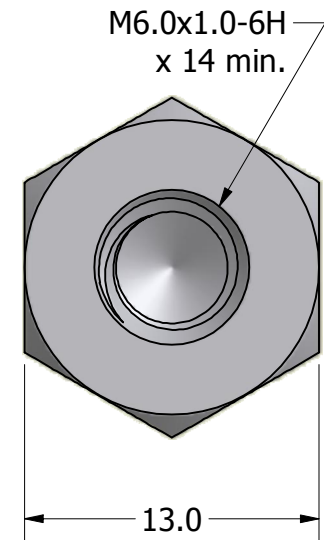
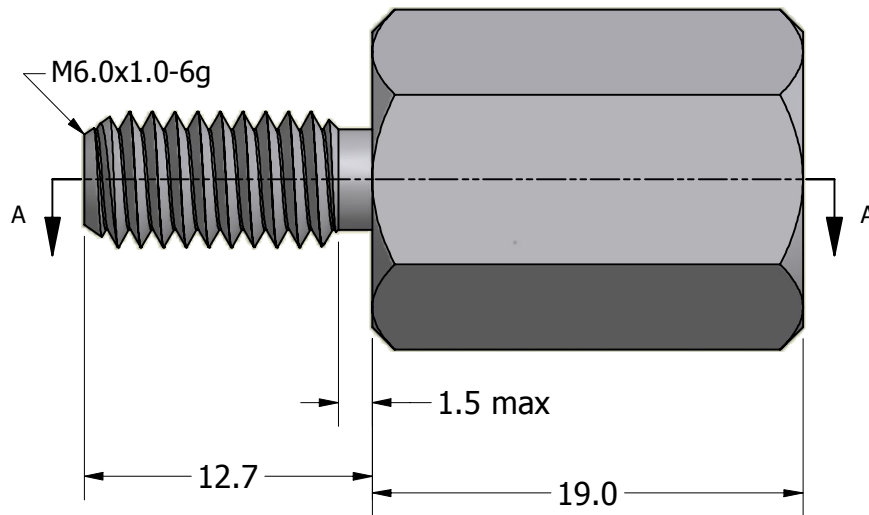

Tolerances Unless Otherwise Specified:

.x Decimal:  $\pm 0.3$   
 .xx Decimal:  $\pm .13$   
 Fraction:  $\pm 1/64$   
 Angle:  $\pm 2^\circ$

**LYN-TRON, INC.**

Part Number:

**SS5182-19.0**

Description:

**13mm Hex M6x1 M/F Standoff**

Drawn By:

**COURTNEYS08/30/2012**

Gauge:

Material:

**Stainless Steel**

Scale:

**3 : 1**