

SECTION A-A

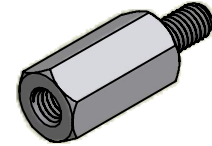

ISO SCALE 1 : 1

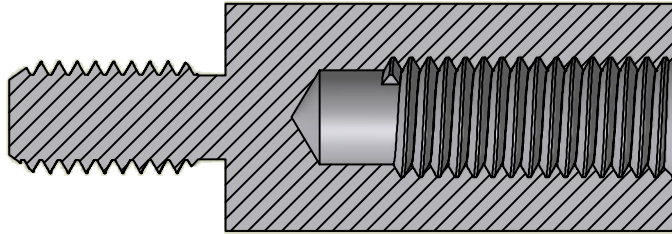
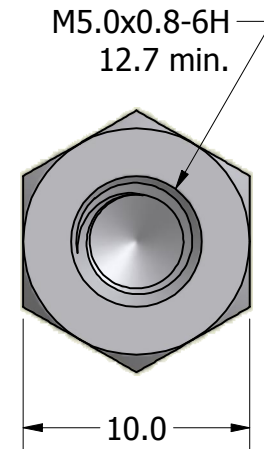
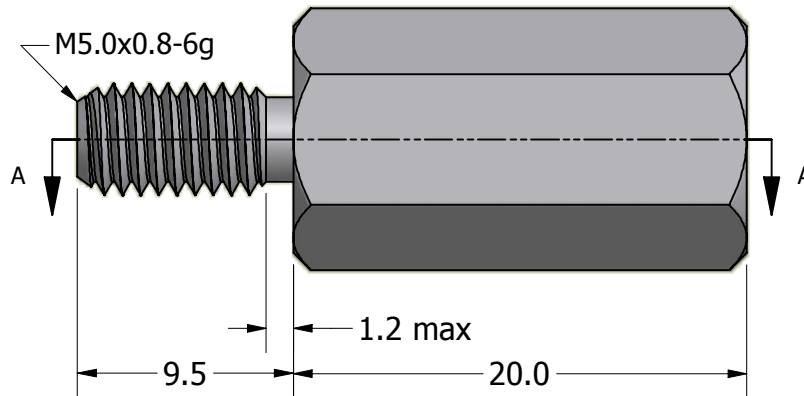

Tolerances Unless Otherwise Specified:

.x Decimal: ± 0.3
 .xx Decimal: ± .13
 Fraction: ± 1/64
 Angle: ± 2°

LYN-TRON, INC.

Part Number:
SS5180-20.0

Description:
10mm Hex M5x.8 M/F Standoff

Drawn By:
COURTNEYS08/14/2012

Gauge:

Material:
Stainless Steel

Scale:
3 : 1