

SECTION A-A

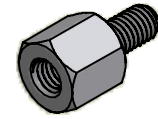

ISO SCALE 1 : 1

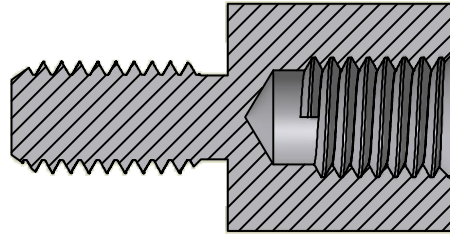
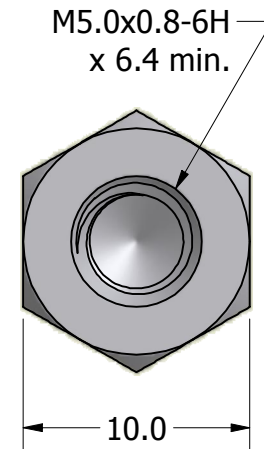
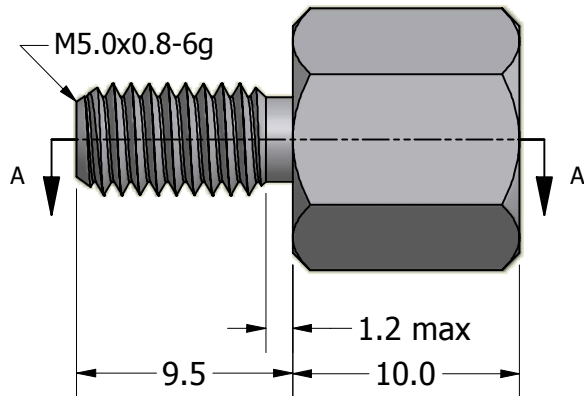

Tolerances Unless Otherwise Specified:

.x Decimal: ± 0.3
.xx Decimal: ± .13
Fraction: ± 1/64
Angle: ± 2°

LYN-TRON, INC.

Part Number:

SS5180-10.0

Description:

10mm Hex M5x.8 M/F Standoff

Drawn By:

COURTNEYS08/14/2012

Gauge:

Material:

Stainless Steel

Scale:

3 : 1