

SECTION A-A

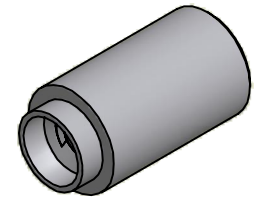

ISO SCALE 2 : 1

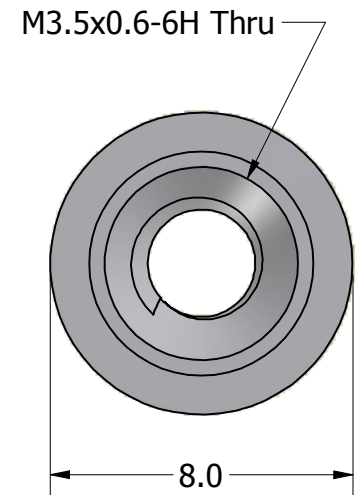
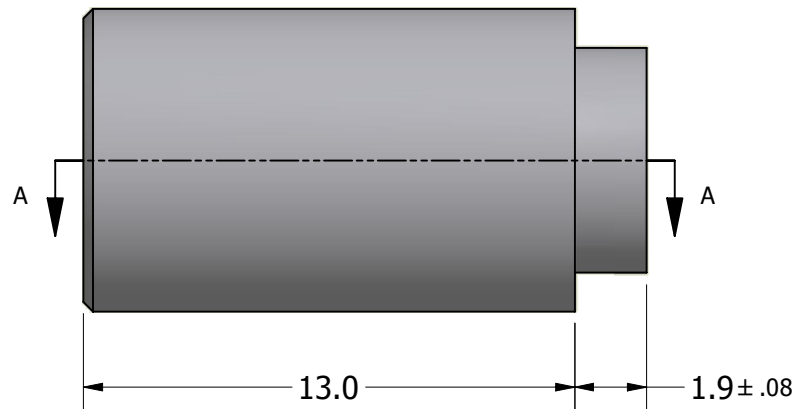

Tolerances Unless Otherwise Specified:

.x Decimal: ± 0.3  
 .xx Decimal: ± .13  
 Fraction: ± 1/64  
 Angle: ± 2°

**LYN-TRON, INC.**

Part Number:

**SS5117A-13.0**

Description:

**8mm Rnd M3.5X.6 Swage Standoff**

Drawn By:

**RICKZ 03/07/2012**

Gauge:

Material:

**Stainless Steel**

Scale:

**5 : 1**