

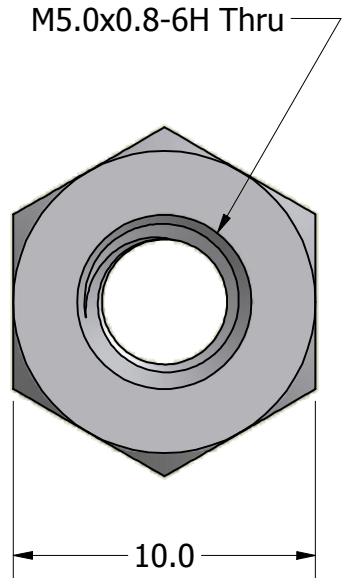

SECTION A-A

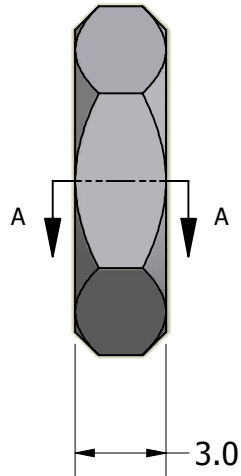

ISO SCALE 1 : 1



Tolerances Unless Otherwise Specified:

**.x Decimal:** ± 0.3  
**.xx Decimal:** ± .13  
**Fraction:** ± 1/64  
**Angle:** ± 2°

**LYN-TRON, INC.**

Part Number:

**SS5086-5080-03.0**

Description:

**10mm Hex Standoff**

Drawn By:

**COURTNEYS08/14/2012**

Gauge:

Material:

**Stainless Steel**

Scale:

**4 : 1**