

SECTION A-A

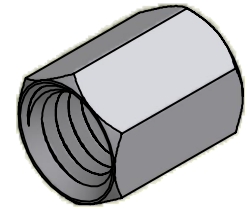

ISO SCALE 3 : 1

M5.0x0.8-6H Thru

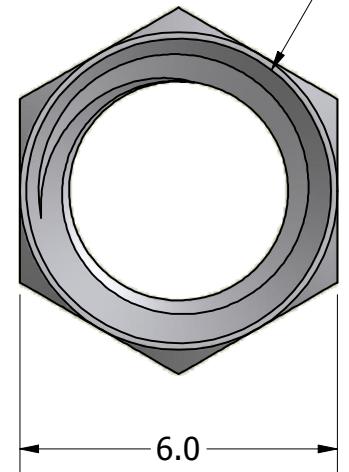
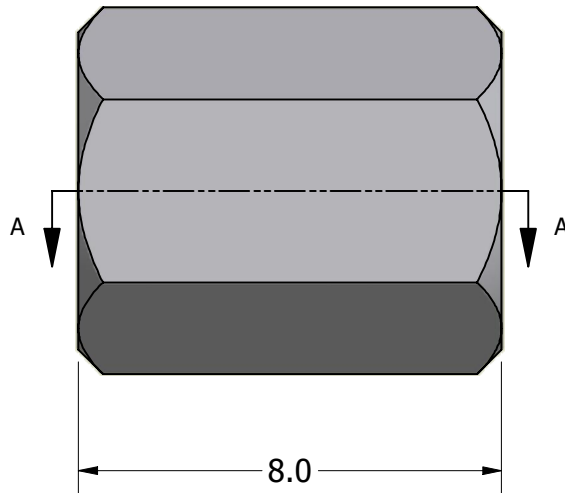

Tolerances Unless Otherwise Specified:

.x Decimal: ± 0.3
.xx Decimal: ± .13
Fraction: ± 1/64
Angle: ± 2°

LYN-TRON, INC.

Part Number:

SS5083-5080-08.0

Description:

6mm Hex Standoff

Drawn By:

COURTNEYS08/09/2012

Gauge:

Material:

Stainless Steel

Scale:

7 : 1