

SECTION A-A

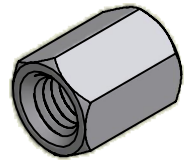

ISO SCALE 3 : 1

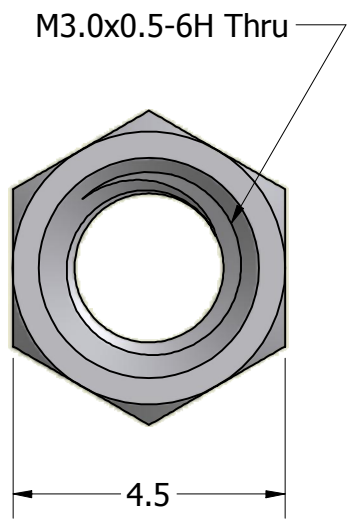
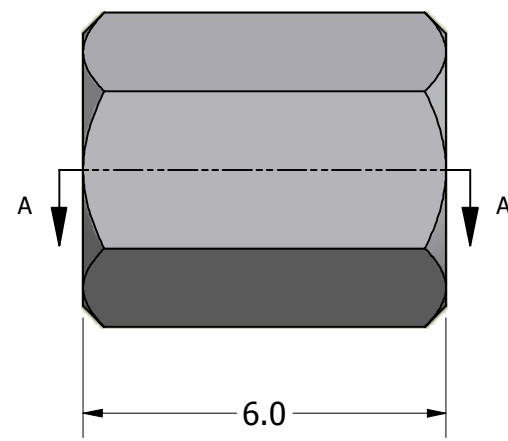

Tolerances Unless Otherwise Specified:		<b>LYN-TRON, INC.</b>	
<b>.x Decimal:</b>	$\pm 0.3$		
<b>.xx Decimal:</b>	$\pm .13$	Part Number:	
<b>Fraction:</b>	$\pm 1/64$	<b>SS5081-3050-06.0</b>	
<b>Angle:</b>	$\pm 2^\circ$	Description:	
		<b>4.5mm Hex Standoff</b>	
Drawn By:	Gauge:	Material:	Scale:
<b>COURTNEYS08/09/2012</b>		<b>Stainless Steel</b>	<b>8 : 1</b>