

SECTION A-A

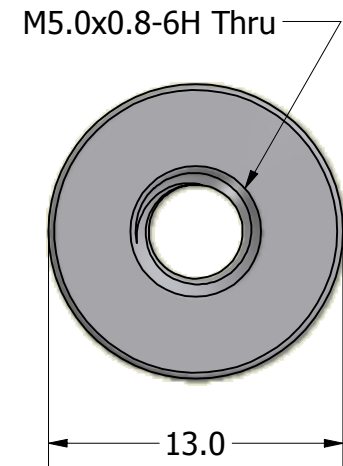

ISO SCALE 1 : 1

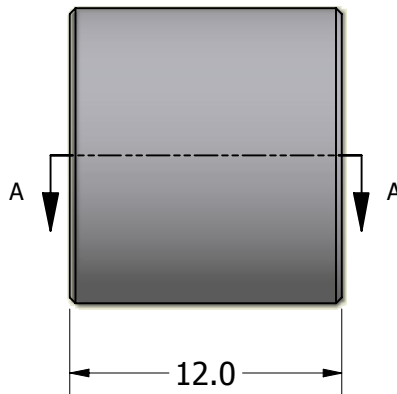

Tolerances Unless Otherwise Specified:

.x Decimal: ± 0.3
.xx Decimal: ± .13
Fraction: ± 1/64
Angle: ± 2°

LYN-TRON, INC.

Part Number:

SS5076-5080-12.0

Description:

13mm Rnd Standoff

Drawn By:

JEFFN

06/20/2010

Gauge:

Material:

Stainless Steel

Scale:

3 : 1