

SECTION A-A

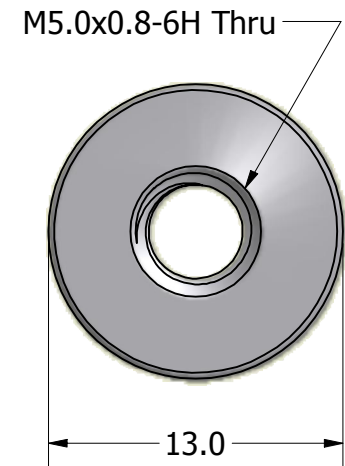

ISO SCALE 1 : 1

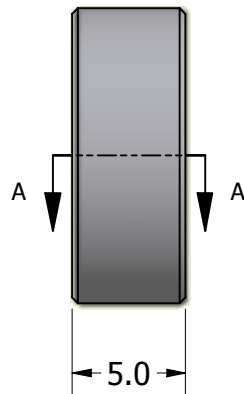

Tolerances Unless Otherwise Specified:

.x Decimal: ± 0.3
 .xx Decimal: $\pm .13$
 Fraction: $\pm 1/64$
 Angle: $\pm 2^\circ$

LYN-TRON, INC.

Part Number:
SS5076-5080-05.0

Description:
13mm Rnd Standoff

Drawn By:
JEFFN 06/20/2010

Gauge:

Material:
Stainless Steel

Scale:
3 : 1