

SECTION A-A

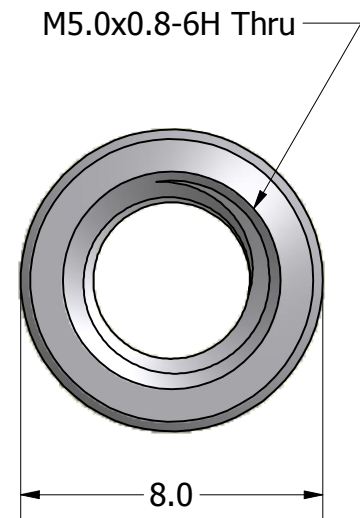

ISO SCALE 2 : 1

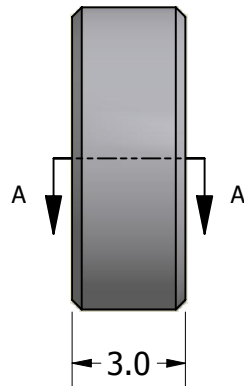

Tolerances Unless Otherwise Specified:

.x Decimal: ± 0.3
.xx Decimal: ± .13
Fraction: ± 1/64
Angle: ± 2°

LYN-TRON, INC.

Part Number:

SS5073-5080-03.0

Description:

8mm Rnd Standoff

Drawn By:

COURTNEYS01/27/2012

Gauge:

Material:

Stainless Steel

Scale:

5 : 1