

SECTION A-A

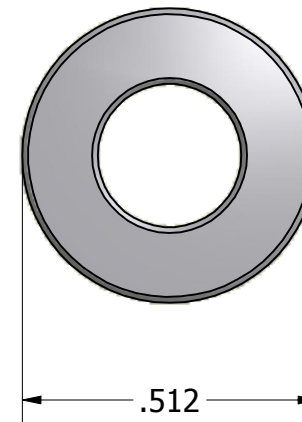

ISO SCALE 1 : 1

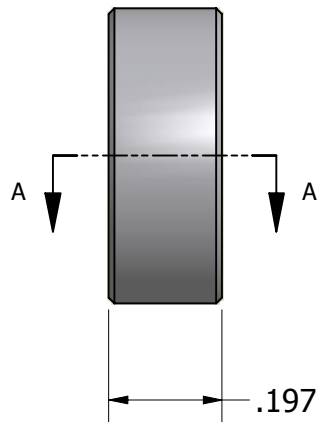

Tolerances Unless Otherwise Specified:

.xx Decimal: ± .02
.xxx Decimal: ± .005
Fraction: ± 1/64
Angle: ± 2°

LYN-TRON, INC.

Part Number:

SS5010-60-05.0

Description:

13mm Round Spacer

Drawn By:

Rick Z 10/4/2011

Gauge:

STD

Material:

Stainless Steel 303

Scale:

3:1