

SECTION A-A

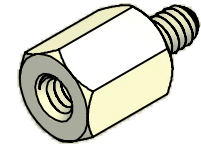

ISO SCALE 2 : 1

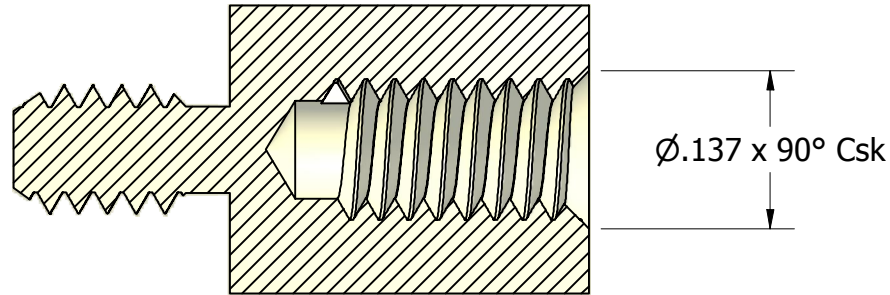
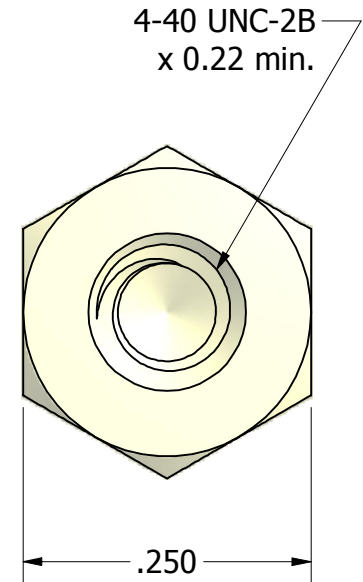
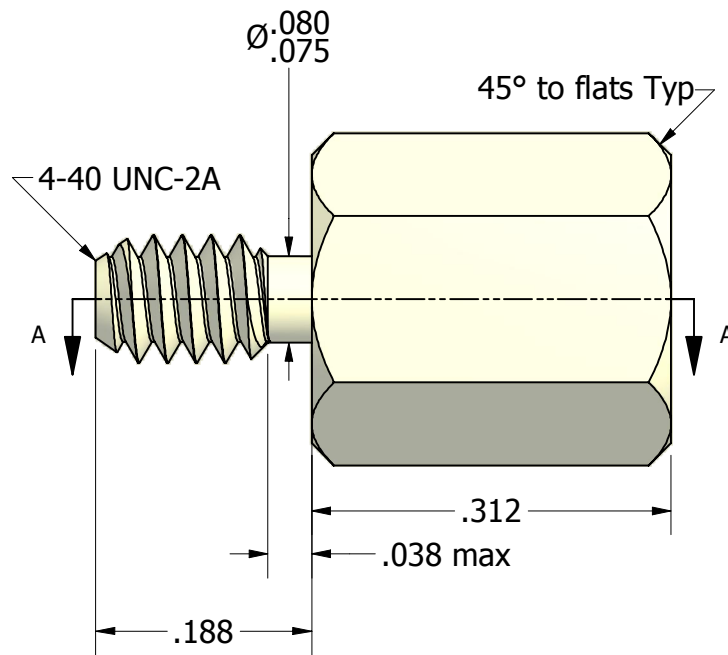

Tolerances Unless Otherwise Specified:

.xx Decimal: $\pm .02$
 .xxx Decimal: $\pm .010$
 Fraction: $\pm 1/64$
 Angle: $\pm 2^\circ$

LYN-TRON, INC.

Part Number:

NY6980-0.312

Description:

1/4 Hex Male-Female Standoff

Drawn By:

RICKZ 02/02/2012

Gauge:

Material:

Nylon

Scale:

6 : 1