

SECTION A-A

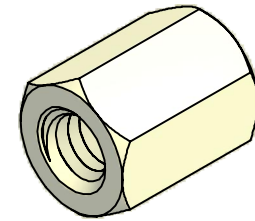

ISO SCALE 2 : 1

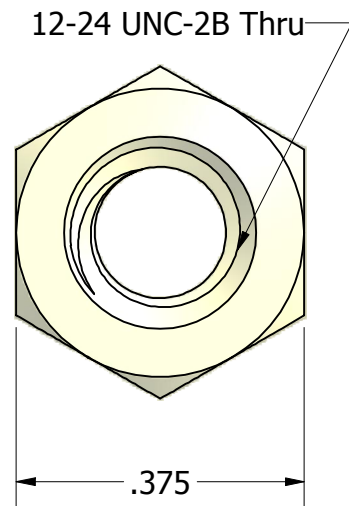
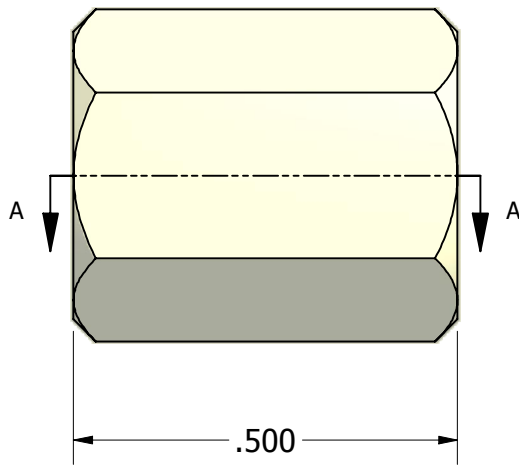

Tolerances Unless Otherwise Specified:			
.xx Decimal:	± .02		
.xxx Decimal:	± .010	Part Number:	
Fraction:	± 1/64	NY6953-1224-0.500	
Angle:	± 2°	Description:	
		3/8 Hex Standoff	
Drawn By:	Gauge:	Material:	Scale:
JEFFN	07/08/2010	Nylon	4 : 1