

SECTION A-A

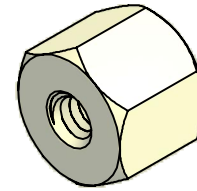

ISO SCALE 2 : 1

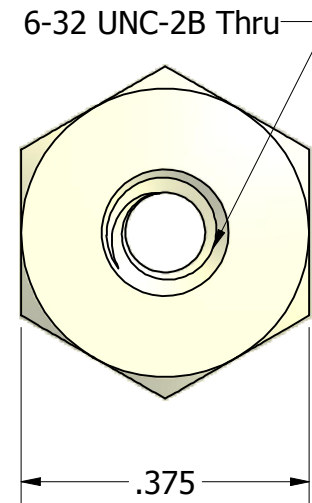
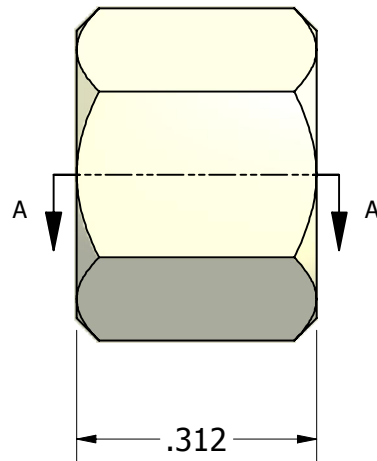

Tolerances Unless Otherwise Specified:

.xx Decimal: $\pm .02$
.xxx Decimal: $\pm .010$
Fraction: $\pm 1/64$
Angle: $\pm 2^\circ$

LYN-TRON, INC.

Part Number:
NY6953-0632-0.312

Description:
3/8 Hex Standoff

Drawn By:
JEFFN 07/08/2010

Gauge:

Material:
Nylon

Scale:
4 : 1