

SECTION A-A

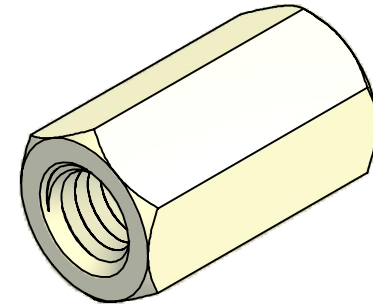

ISO SCALE 3 : 1

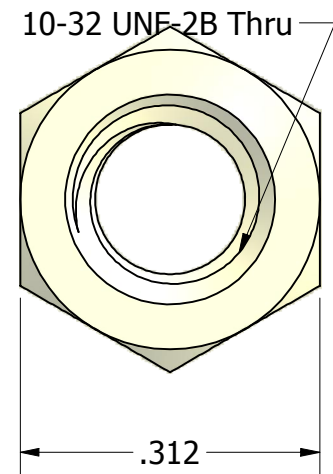
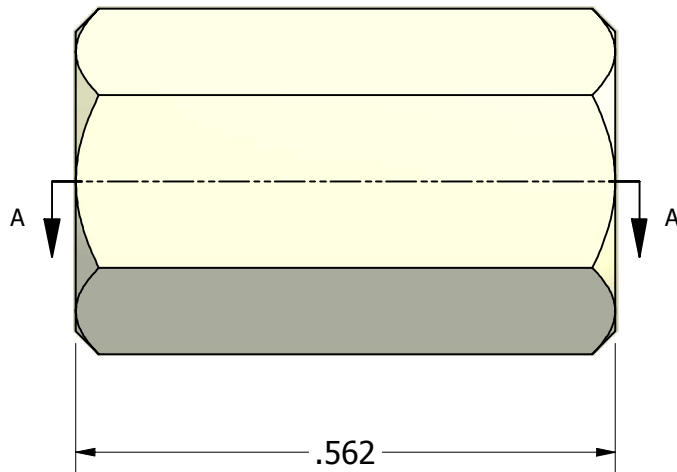

Tolerances Unless Otherwise Specified:

.xx Decimal: $\pm .02$
.xxx Decimal: $\pm .010$
Fraction: $\pm 1/64$
Angle: $\pm 2^\circ$

LYN-TRON, INC.

Part Number:

NY6952-1032-0.562

Description:

5/16 Hex Standoff

Drawn By:

JEFFN

07/08/2010

Gauge:

Material:

Nylon

Scale:

5 : 1