

SECTION A-A

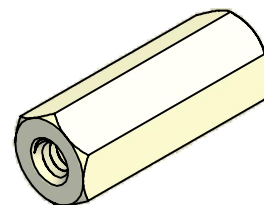

ISO SCALE 2 : 1

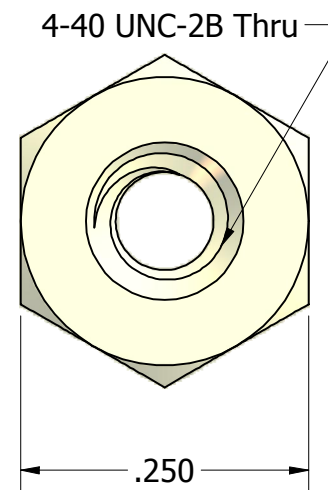
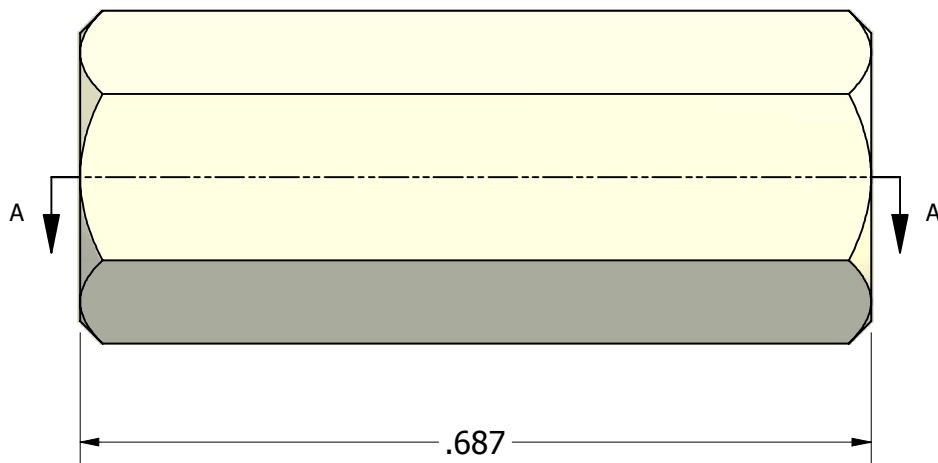

Tolerances Unless Otherwise Specified:

.xx Decimal: ± .02
.xxx Decimal: ± .010
Fraction: ± 1/64
Angle: ± 2°

LYN-TRON, INC.

Part Number:
NY6951-0440-0.687

Description:
1/4 Hex Standoff

Drawn By:
JEFFN 07/08/2010

Gauge:
 Material:
Nylon

Scale:
6 : 1