

SECTION A-A

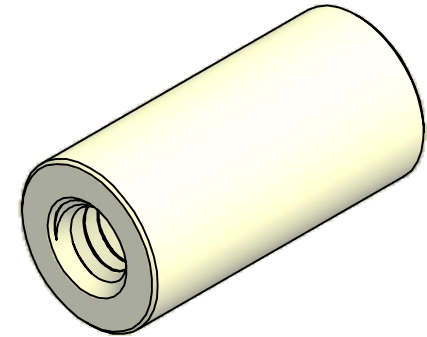

ISO SCALE 2 : 1

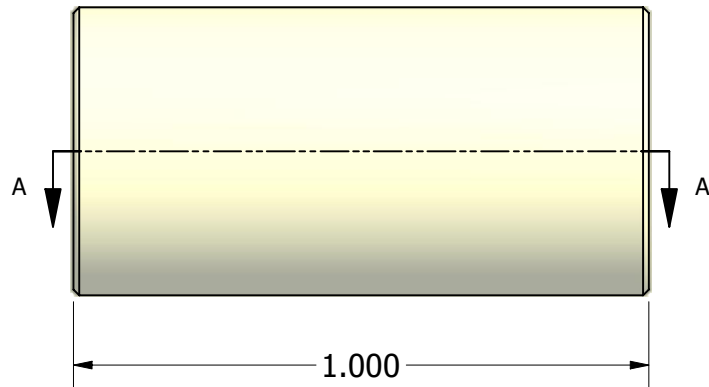

1/4-20 UNC-2B Thru

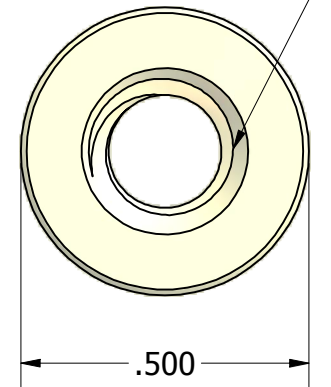

Tolerances Unless Otherwise Specified:

.xx Decimal: $\pm .02$
.xxx Decimal: $\pm .010$
Fraction: $\pm 1/64$
Angle: $\pm 2^\circ$

LYN-TRON, INC.

Part Number:

NY6945-2520-1.000

Description:

1/2 Round Standoff

Drawn By:

JEFFN

07/07/2010

Gauge:

Material:

Nylon

Scale:

3 : 1