

SECTION A-A

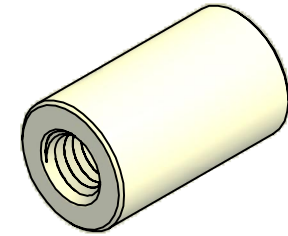

ISO SCALE 2 : 1

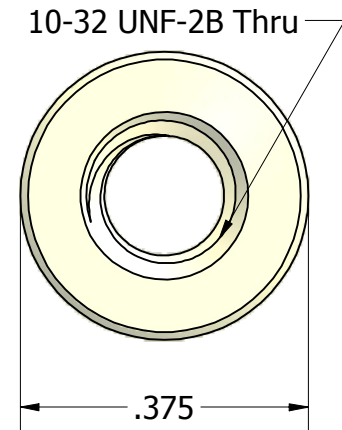
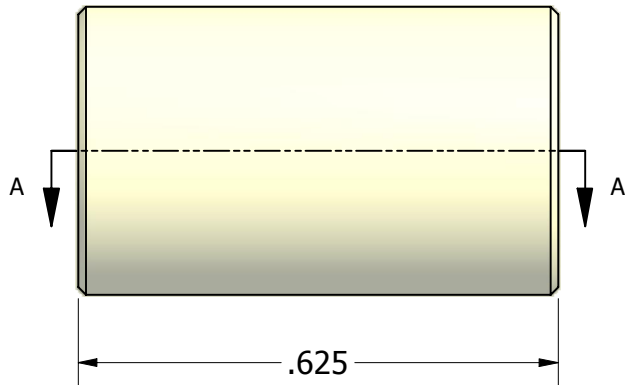

Tolerances Unless Otherwise Specified:

**.xx Decimal:**  $\pm .02$   
**.xxx Decimal:**  $\pm .010$   
**Fraction:**  $\pm 1/64$   
**Angle:**  $\pm 2^\circ$

**LYN-TRON, INC.**

Part Number:  
**NY6943-1032-0.625**

Description:  
**3/8 Round Standoff**

Drawn By:  
**JEFFN 07/07/2010**

Gauge:

Material:  
**Nylon**

Scale:  
**4 : 1**