

SECTION A-A

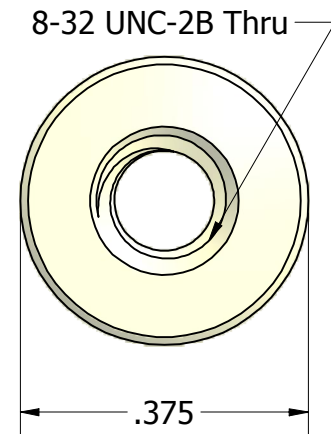

ISO SCALE 2 : 1

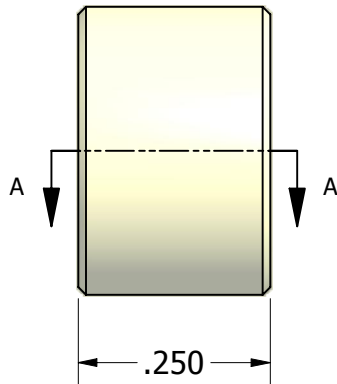

Tolerances Unless Otherwise Specified:

.xx Decimal: ± .02
.xxx Decimal: ± .010
Fraction: ± 1/64
Angle: ± 2°

LYN-TRON, INC.

Part Number:
NY6943-0832-0.250

Description:
3/8 Round Standoff

Drawn By:
JEFFN 07/07/2010

Gauge:

Material:
Nylon

Scale:
4 : 1