

SECTION A-A

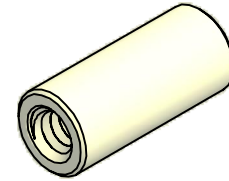

ISO SCALE 2 : 1

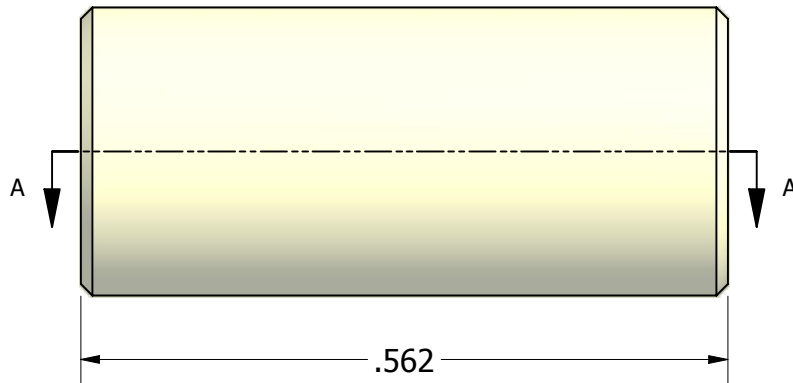

6-32 UNC-2B Thru

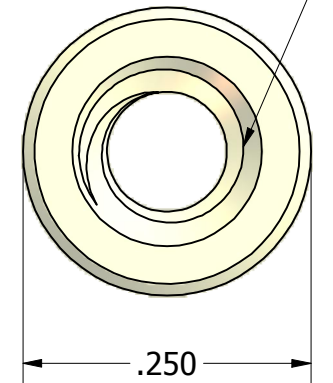

Tolerances Unless Otherwise Specified:

**.xx Decimal:**  $\pm .02$   
**.xxx Decimal:**  $\pm .010$   
**Fraction:**  $\pm 1/64$   
**Angle:**  $\pm 2^\circ$

**LYN-TRON, INC.**

Part Number:

**NY6941-0632-0.562**

Description:

**1/4 Round Standoff**

Drawn By:

**JEFFN**

**07/06/2010**

Gauge:

Material:

**Nylon**

Scale:

**6 : 1**