

SECTION A-A

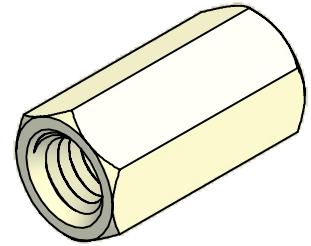

ISO SCALE 3 : 1

M4.0x0.7-6H Thru

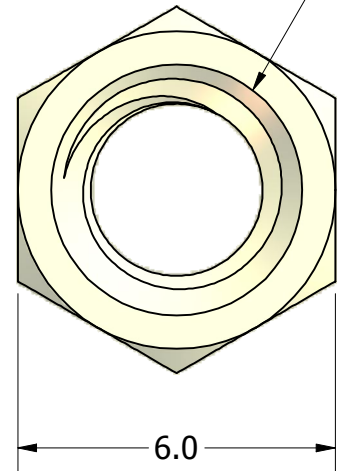
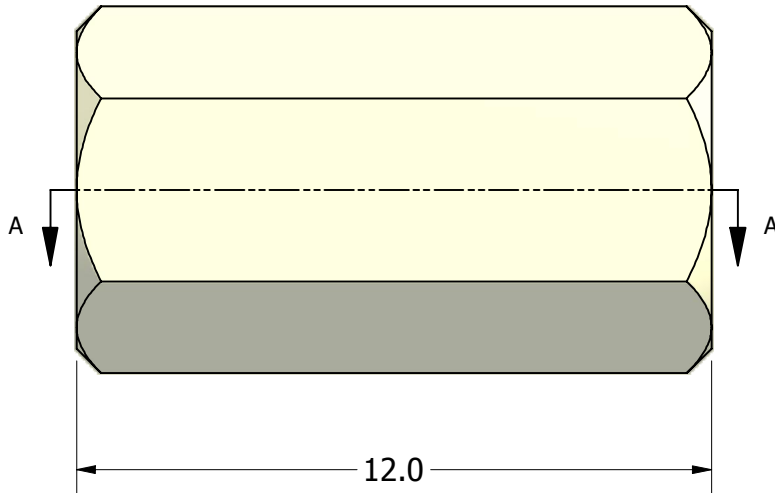

Tolerances Unless Otherwise Specified:

.x Decimal: ± 0.3
 .xx Decimal: $\pm .13$
 Fraction: $\pm 1/64$
 Angle: $\pm 2^\circ$

LYN-TRON, INC.

Part Number:

NY5083-4070-12.0

Description:

6mm Hex Standoff

Drawn By:

COURTNEYS06/26/2012

Gauge:

Material:

Nylon

Scale:

7 : 1