

SECTION A-A

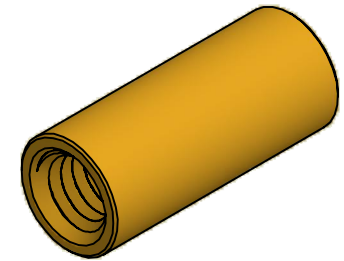

ISO SCALE 3 : 1

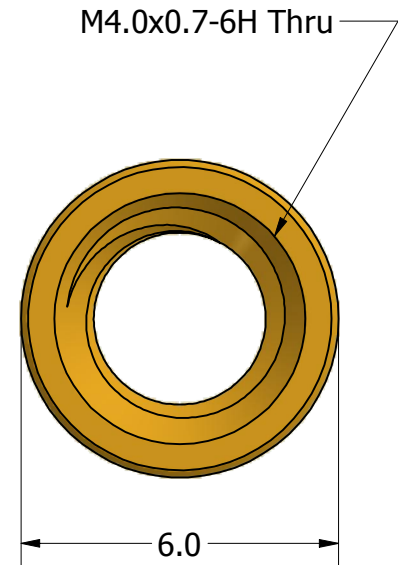
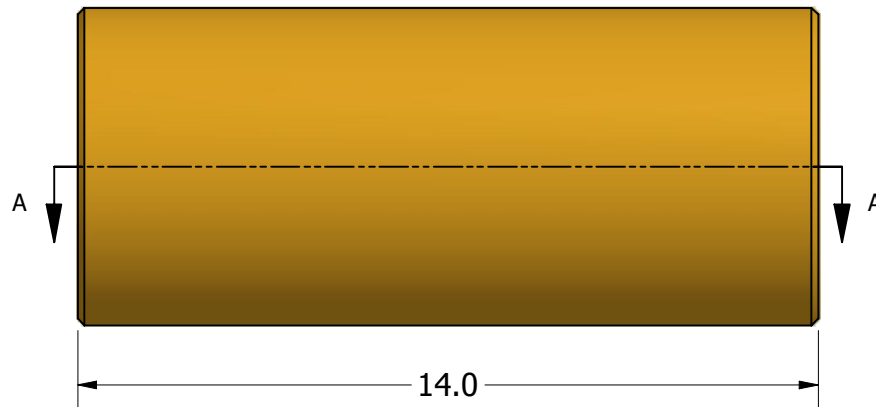

Tolerances Unless Otherwise Specified:

.x Decimal: ± 0.3
 .xx Decimal: $\pm .13$
 Fraction: $\pm 1/64$
 Angle: $\pm 2^\circ$

LYN-TRON, INC.

Part Number:

NY5071-4070-14.0

Description:

6mm Rnd Standoff

Drawn By:

JEFFN

06/20/2010

Gauge:

Material:

Nylon

Scale:

7 : 1