

ISO SCALE 2 : 1

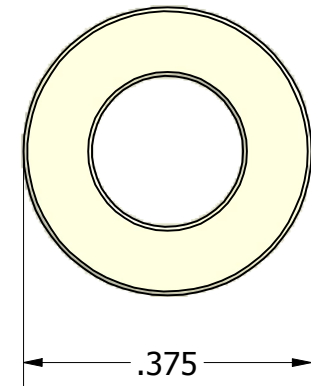
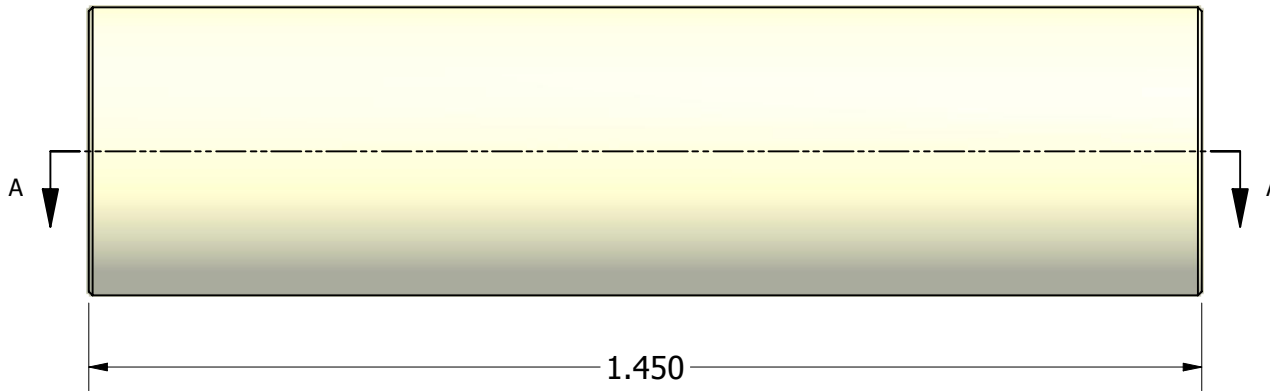

Notes:
 (1) Break all sharp edges

Tolerances Unless Otherwise Specified:

.xx Decimal: ± .02
.xxx Decimal: ± .005
Fraction: ± 1/64
Angle: ± 2°

LYN-TRON, INC.

Part Number:
NAS61-3B-145

Description:
3/8" ROUND SPACER (NYLON)

Drawn By:
RICKZ 11/15/2011

Gauge:
STD

Material:
Nylon

Scale:
4 : 1