

ISO SCALE 2 : 1

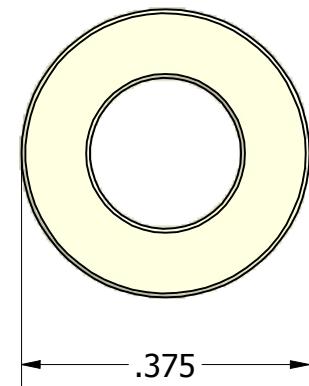
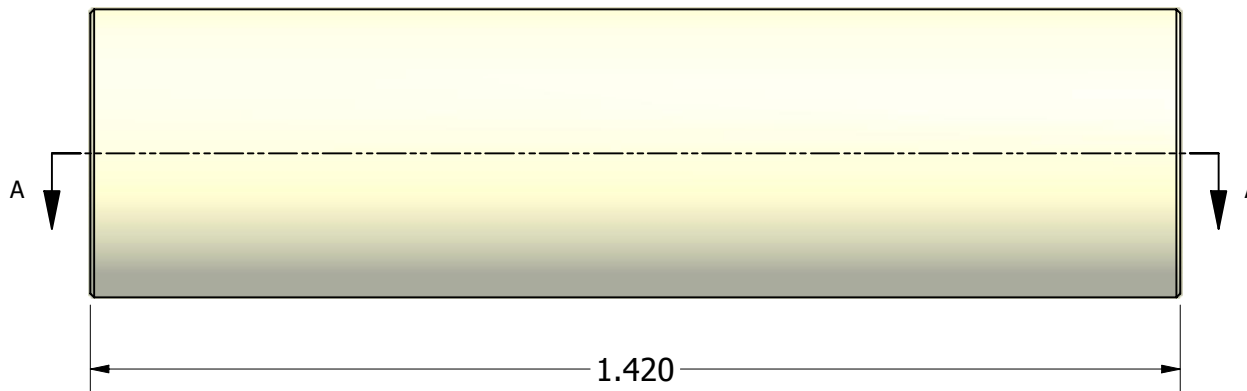

Notes:
 (1) Break all sharp edges

Tolerances Unless Otherwise Specified:

.xx Decimal: ± .02
.xxx Decimal: ± .005
Fraction: ± 1/64
Angle: ± 2°

LYN-TRON, INC.

Part Number:

NAS61-3B-142

Description:

3/8" ROUND SPACER (NYLON)

Drawn By:

RICKZ

11/15/2011

Gauge:

STD

Material:

Nylon

Scale:

4 : 1