

SECTION A-A

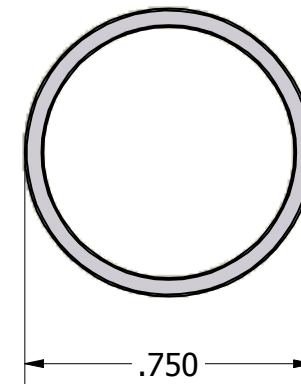

ISO SCALE 1 : 1

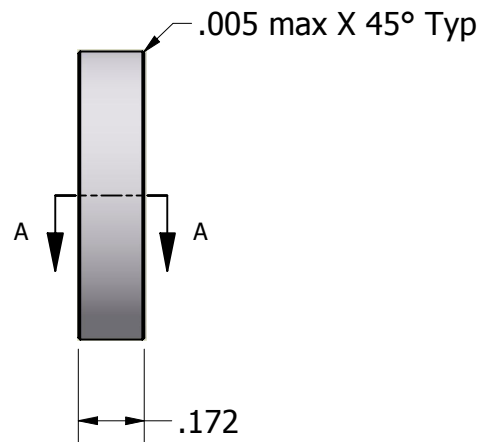

Finish: NO FINISH  
 Spec:  
 Type:  
 Class:

Tolerances Unless Otherwise Specified:		<b>LYN-TRON, INC.</b>	
.xx Decimal: ± .02			
.xxx Decimal: ± .005		Part Number:	
Fraction: ± 1/64		<b>NAS43DD10-11A</b>	
Angle: ± 2°		Description:	
		<b>3/4" ROUND SPACER (ALUMINUM)</b>	
Drawn By:	Gauge:	Material:	Scale:
<b>RICKZ 09/01/2011</b>		<b>Aluminum 2024-T4</b>	<b>2 : 1</b>