

ISO SCALE 2 : 1

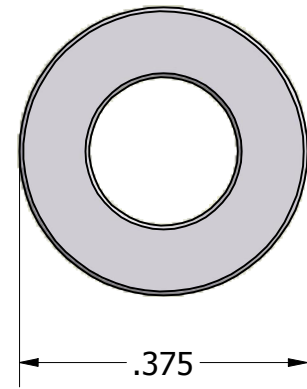
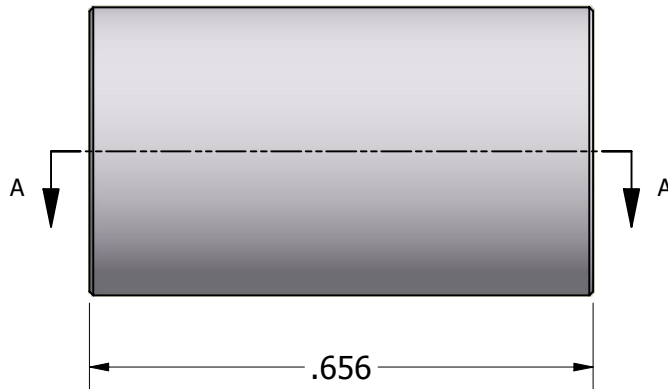

Finish: NO FINISH
 Spec:
 Type:
 Class:

Tolerances Unless Otherwise Specified:

.xx Decimal: ± .02
.xxx Decimal: ± .005
Fraction: ± 1/64
Angle: ± 2°

LYN-TRON, INC.

Part Number:

NAS42DD6-42A

Description:

3/8" ROUND SPACER (ALUMINUM)

Drawn By:

RICKZ

10/18/2011

Gauge:

STD

Material:

Aluminum 2024-T4

Scale:

4 : 1