

SECTION A-A

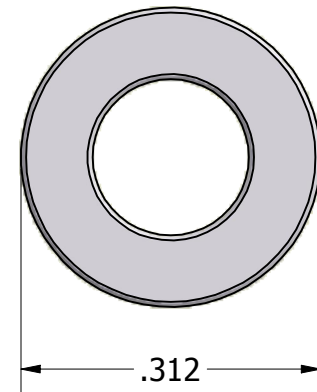

ISO SCALE 2 : 1

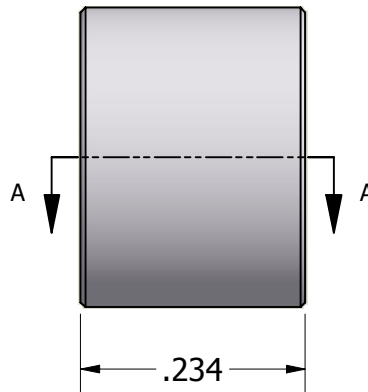

Finish: NO FINISH
 Spec:
 Type:
 Class:

Tolerances Unless Otherwise Specified:			
.xx Decimal:	± .02		
.xxx Decimal:	± .005	Part Number:	
Fraction:	± 1/64	NAS42DD5-15A	
Angle:	± 2°	Description:	
		5/16" ROUND SPACER (ALUMINUM)	
Drawn By:	Gauge:	Material:	Scale:
RICKZ	10/12/2011	STD	Aluminum 2024-T4
			5 : 1