

SECTION A-A

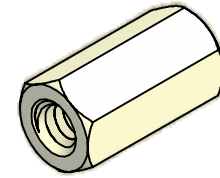

ISO SCALE 2 : 1

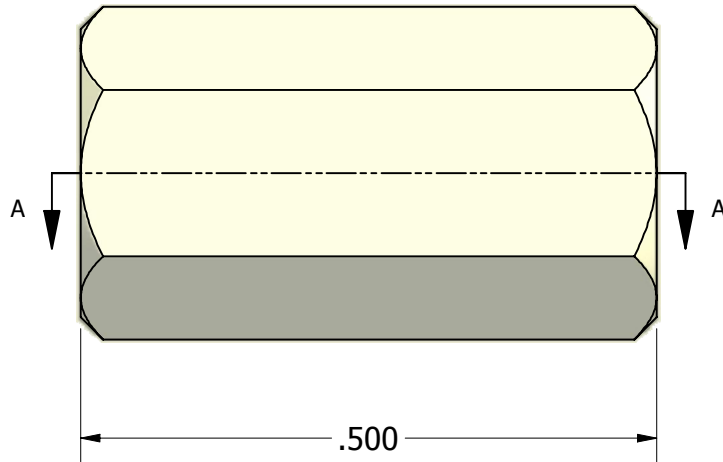

6-32 UNC-2B Thru

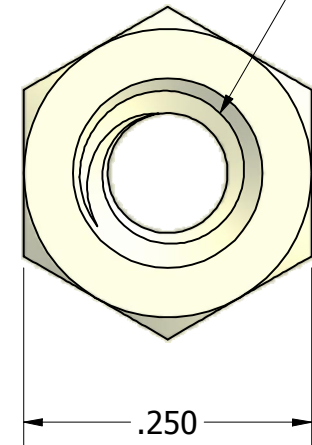

Finish: Unplated
 Spec: N/A
 Type: N/A
 Class: N/A

Tolerances Unless Otherwise Specified:

.xx Decimal: ± .02
.xxx Decimal: ± .010
Fraction: ± 1/64
Angle: ± 2°

LYN-TRON, INC.

Part Number:

NAS1831H4C08

Description:

1/4" HEX FEMALE STANDOFF

Drawn By:

COURTNEYS08/09/2012

Gauge:

STD

Material:

Nylon (6/6)

Scale:

6 : 1