

SECTION A-A

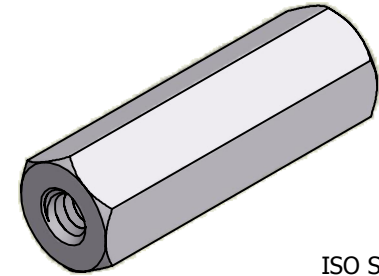

ISO SCALE 2 : 1

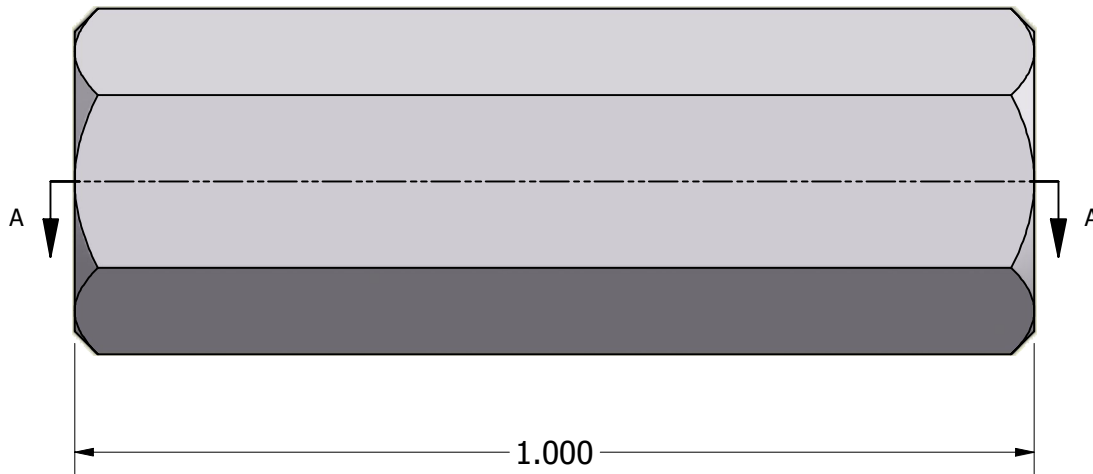

6-32 UNC-2B Thru

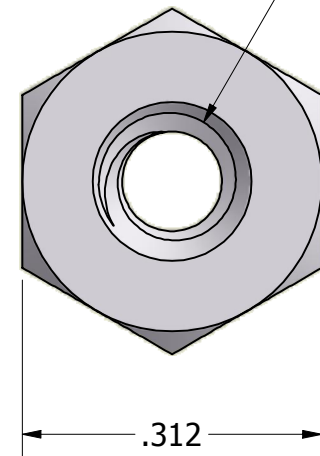

Finish:
Spec:
Type:
Class:

Tolerances Unless Otherwise Specified:

.xx Decimal: ± .02
.xxx Decimal: ± .005
Fraction: ± 1/64
Angle: ± 2°

LYN-TRON, INC.

Part Number:

NAS1831AC5C16

Description:

5/16" HEX FEMALE STANDOFF

Drawn By:

COURTNEYS08/09/2012

Gauge:

STD

Material:

Aluminum 2024-T4 (T6)

Scale:

5 : 1