

SECTION A-A

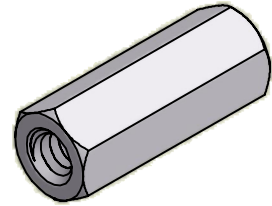

ISO SCALE 2 : 1

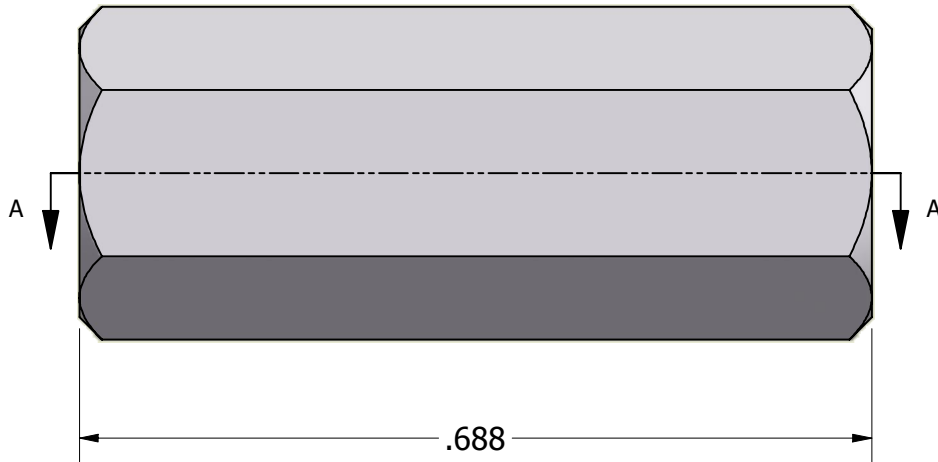

6-32 UNC-2B Thru

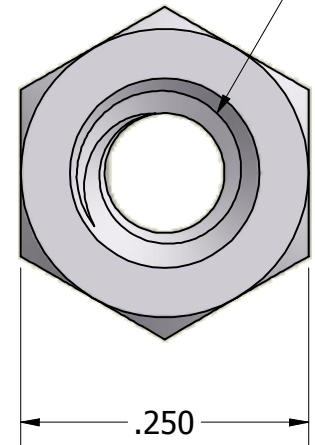

Finish:
Spec:
Type:
Class:

Tolerances Unless Otherwise Specified:

.xx Decimal: $\pm .02$
.xxx Decimal: $\pm .005$
Fraction: $\pm 1/64$
Angle: $\pm 2^\circ$

LYN-TRON, INC.

Part Number:

NAS1831A4C11

Description:

1/4" HEX FEMALE STANDOFF

Drawn By:

COURTNEYS08/09/2012

Gauge:

STD

Material:

Aluminum 2024-T4 (T6)

Scale:

6 : 1