

SECTION A-A

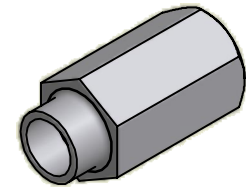

ISO SCALE 3 : 1

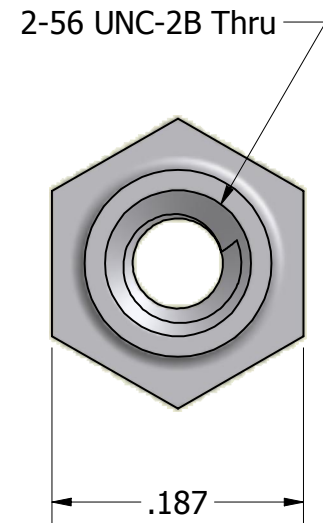
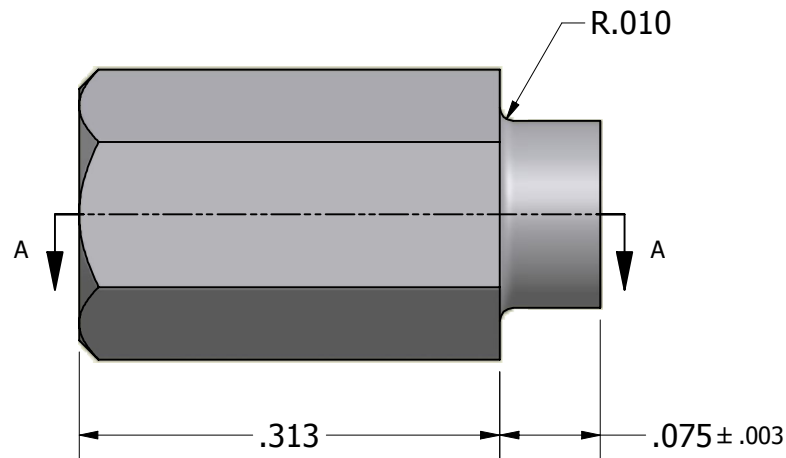

Finish:
Spec:
Type:
Class:

Tolerances Unless Otherwise Specified:

.xx Decimal: ± .02
.xxx Decimal: ± .005
Fraction: ± 1/64
Angle: ± 2°

LYN-TRON, INC.

Part Number:

NAS1830C02A05

Description:

3/16 HEX" SWAGE STANDOFF

Drawn By:

COURTNEYS08/16/2012

Gauge:

STD

Material:

Stainless Steel (303)

Scale:

7 : 1