

SECTION A-A

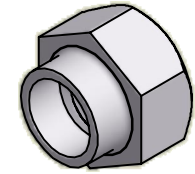

ISO SCALE 3 : 1

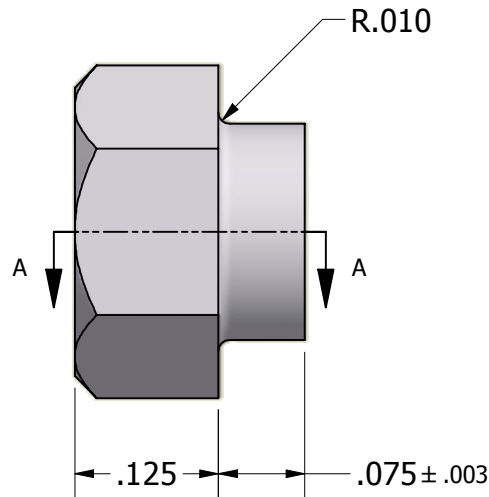

6-32 UNC-2B Thru

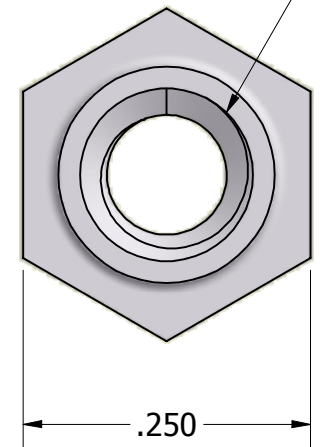

Finish:
Spec:
Type:
Class:

Tolerances Unless Otherwise Specified:

.xx Decimal: ± .02
.xxx Decimal: ± .005
Fraction: ± 1/64
Angle: ± 2°

LYN-TRON, INC.

Part Number:

NAS1830AC04A02

Description:

1/4 HEX" SWAGE STANDOFF

Drawn By:

COURTNEYS08/28/2012

Gauge:

STD

Material:

Aluminum 2024-T4 (T6)

Scale:

6 : 1