

SECTION A-A

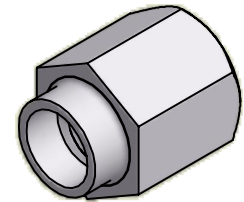

ISO SCALE 3 : 1

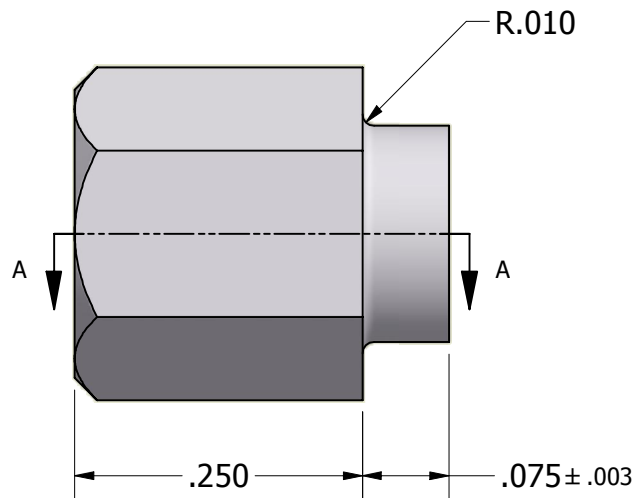

6-32 UNC-2B Thru

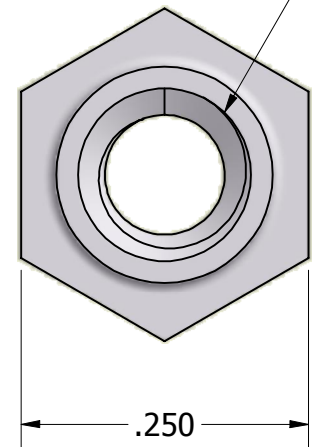

Finish:  
Spec:  
Type:  
Class:

Tolerances Unless Otherwise Specified:

**.xx Decimal:** ± .02  
**.xxx Decimal:** ± .005  
**Fraction:** ± 1/64  
**Angle:** ± 2°

**LYN-TRON, INC.**

Part Number:

**NAS1830A04A04**

Description:

**1/4 HEX" SWAGE STANDOFF**

Drawn By:

**COURTNEYS08/28/2012**

Gauge:

**STD**

Material:

**Aluminum 2024-T4 (T6)**

Scale:

**6 : 1**