

ISO SCALE 2 : 1

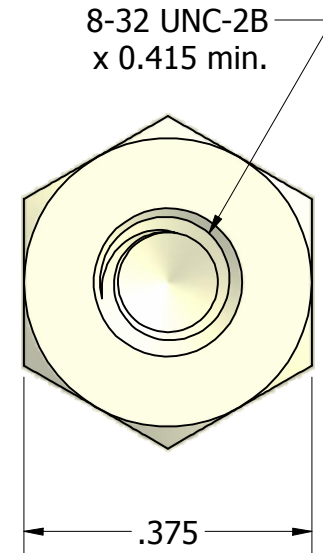
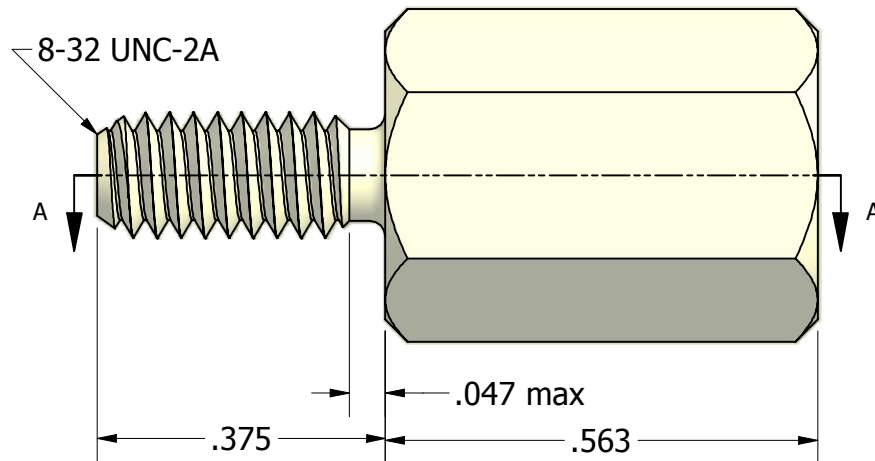

Finish: Unplated
 Spec: N/A
 Type: N/A
 Class: N/A

All information on this document is owned by Lyn-Tron, Inc. and is not to be copied or used without prior written consent.
 LYN-TRON, INC. www.lyntron.com 800-423-2734

Tolerances Unless Otherwise Specified:

.xx Decimal: ± .02
.xxx Decimal: ± .010
Fraction: ± 1/64
Angle: ± 2°

LYN-TRON, INC.

Part Number:

NAS1829H6G09

Description:

3/8" HEX MALE FEMALE STANDOFF

Drawn By:

COURTNEYS09/11/2012

Gauge:

STD

Material:

Nylon (6/6)

Scale:

4 : 1