

ISO SCALE 2 : 1

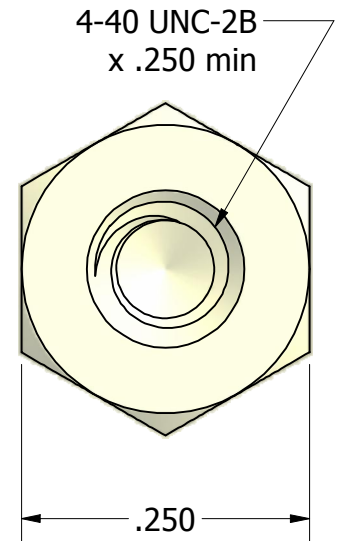
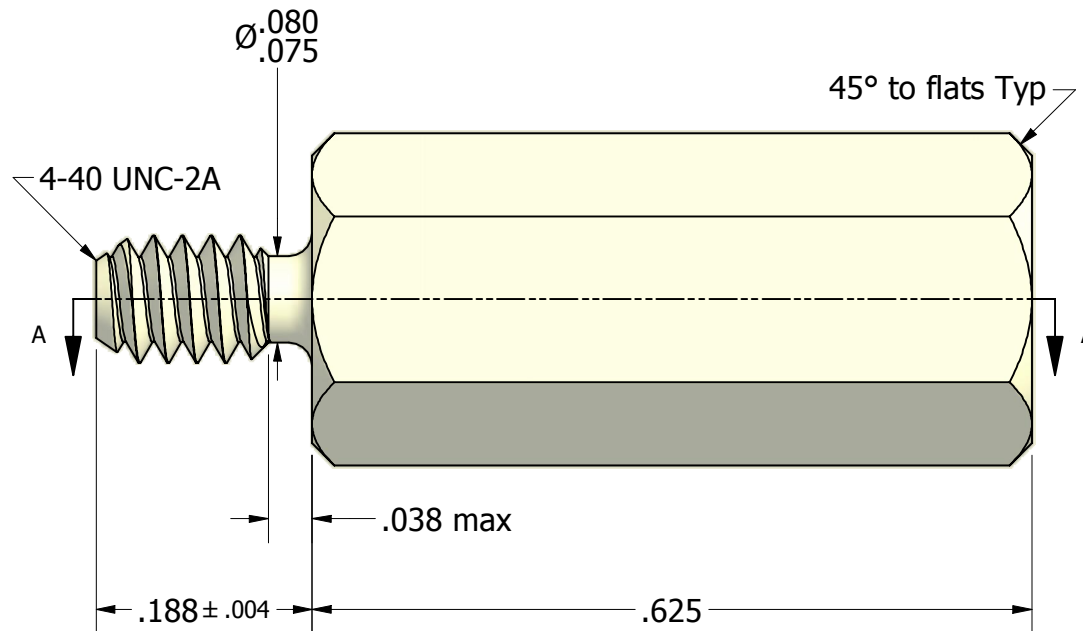

Finish: Unplated
Spec: N/A
Type: N/A
Class: N/A

Tolerances Unless Otherwise Specified:

.xx Decimal: ± .02
.xxx Decimal: ± .010
Fraction: ± 1/64
Angle: ± 2°

LYN-TRON, INC.

Part Number:

NAS1829H4C10

Description:

1/4" HEX MALE FEMALE STANDOFF

Drawn By:

COURTNEYS08/30/2012

Gauge:

STD

Material:

Nylon (6/6)

Scale:

6 : 1